

2026 PRODUCT CATALOG

- ✓ Trims & Flashing
- ✓ Metal Roofing
- ✓ Ventilation
- ✓ Drywall Bead
- ✓ Stucco & Plaster
- ✓ Soffit & Fascia
- ✓ Steel Framing

Quality Guaranteed



Southeastern Metals™ produces over 3,000 galvanized, steel and aluminum building components, specializing in metal roofing, ventilation products, trims, flashings, steel framing, corner bead and drywall accessories. Every product is precision engineered and manufactured to the highest standards to promote greater strength and durability while enhancing overall structural integrity after installation.

Since the company's foundation in 1963, Southeastern Metals™ has grown into one of the region's leading manufacturers of metal building products. In 1997, Gibraltar Industries acquired the company, uniting the quality product line of Southeastern Metals™ with the nationally respected brand name of Gibraltar.

Gibraltar Industries Building Accessories Division brings together leading manufacturers and distributors of products. These solutions serve a large number of customers in a variety of industries from facilities in the across the United States. Our products and services are designed with a focus on delivering value to end users, challenging conventional norms, and making data driven decisions. By embracing this commitment, we aim to be leaders in our categories and create value for the channels we serve.

GALVANIZED STEEL

All galvanized steel products are zinc coated as specified by ASTM-A-653, Federal specification AA-S-775 E.

Caution: Do not use in contact with copper or pressure treated lumber

ALUMINUM

All aluminum products are as specified by ASTM B-209, Federal specification QQ-A-250 E.

Caution: Avoid direct contact with dissimilar metal and with concrete or mortar

FINISH

All bare 26 gauge galvanized products have a zinc coating of G-90 for corrosion resistance.

All painted products have a gloss polyester color coating over primer.

CUSTOMER SERVICE: 800-874-0335 • FAX 904-696-2536 • DELIVERIES: 7 TO 10 BUSINESS DAYS

GALVANIZED & GALVALUME STEEL

Gauge	Thickness	Min.	Max.	Lbs./Sq. Ft.
20	0.0396	0.0356	0.0436	1.656
22	0.0336	0.0296	0.0376	1.405
24	0.0276	0.0236	0.0316	1.154
26	0.0217	0.0179	0.0247	0.907
28	0.0187	0.0157	0.0217	0.782
29	0.0172	0.0142	0.0202	0.719
30	0.0157	0.0127	0.0187	0.657
ST	0.0120	0.0118	0.0125	0.507
HT	0.0100	0.0098	0.0115	0.408

ALUMINUM

Gauge	Thickness	Min.	Max.	Lbs./Sq. Ft.
20	0.0320	0.0305	0.0365	0.451
22	0.0253	0.0224	0.0284	0.352
24	0.0201	0.0173	0.0234	0.282
26	0.0159	0.0123	0.0183	0.224
28	0.0126	0.0119	0.0132	0.177
29	0.0113	0.0112	0.0122	0.159
30	0.0100	0.0095	0.0115	0.141

Metal Roofing

5V Crimp	4
1 ¼ Corrugated	5
2 ½ Corrugated	6
PBR Panel/R Panel	7
Sem-Lok™	8
SM-Rib	9

Metal Roofing Flashings

Flashing Drawings.....	10
Flashing Tables	12

Metal Roofing Accessories

Ridge Roll Flashing.....	14
Closure Strips	14
Woodfast Screws	14
Butyl Tape.....	14
Pipe Boots	14
Metal Roof Sealant.....	14

Coil & Flat Sheets

Coil	15
Flat Sheet Items.....	15

Trims & Flashings

Galvanized Angle Flashing	16
Galvalume Angle Flashing	16
Aluminum Angle Flashing	16
Hemmed Galvanized Angle Flashing	16
Painted Galvanized Angle Flashing.....	16
Painted Galvanized Angle Flashing.....	16
Apron/Dormer Flashing - Mill Finish.....	17
Apron/Dormer Flashing - Painted.....	17
Bullet Boot	17
Galvanized Roof Edge	18
Galvalume Roof Edge	18
Painted Roof Edge.....	18
Hemmed and Ribbed Roof Edge	18
Galvanized Eave Drip	19
Painted Galvanized Eave Drip - ST Gauge	19
Galvalume Eave Drip - 26 Gauge.....	19
Painted Galvanized Eave Drip - 26 Gauge	19
Aluminum Eave Drip - ST Gauge	20
18 in. Valley	20
Pre-Formed 18 in. W-Valley	20
Pre-Formed 24 in. W-Valley	20
Ridge Roll.....	21
Water Diverter	21
Stucco Flashing	21
Z-Flashing	21

Step Flashing • Flat Sheets

Aluminum Step Flashing	22
Step Flashing - CONTRACTOR PACKS	22
Galvanized Steel Flat Sheets.....	22
Galvanized Steel Step Flashing	22
Painted Galvanized Steel Step Flashing.....	22
Galvalume Flat Sheets.....	22

Roll Flashing

Galvanized Roll Flashing.....	23
Aluminum Roll Flashing - EC Gauge.....	23
Painted Aluminum Roll Flashing	23
Galvalume Roll Flashing - 26 Gauge	23

Tile Accessories

Tile Runner	23
Tile Closure	23

Ventilation

Gooseneck Vents	24
Weather Vent™	24
Total JACK™	24
Universal Ridge Vent.....	25
Roof Jack.....	25
Soffit	25

Drywall Corner Bead

J-Bead	26
Corner Bead.....	26
Bullnose Corner Bead	26
Arched Vinyl Corner Bead	26

Construction Hardware

H-Moulding	27
Termite Shield.....	27

Stucco & Plaster

Casing Bead	28
Expanded Outside Corner Bead	28
Expanded Inside Corner Bead.....	28
Galvanized Kal-Korner.....	28
Vinyl Corner Bead.....	28

Steel Framing

Diamond Steel Framing™ Stud.....	29
Diamond Steel Framing™ Track	29
Furring Channel	29

SEMCO Colors

Steel Flashing Colors.....	30
Aluminum Flashing Colors	30
Aluminum Ventilation Colors	31
Aluminum Soffit Colors.....	31

5V Crimp Exposed fastener roofing panel. 24 inch width coverage. Applications: Residential, Agricultural, Architectural, Light Commercial, Industrial



Code Approvals

UL Fire Resistant Directory #R20735
 Miami Dade NOA #: 11-0714.08
 Florida Building #FL-11175

Testing Data & Specifications

Accelerated testing 2000 hours - ASTM G23
 Salt Spray testing 1000 hours - ASTM B117
 Fire Testing - ASTM E108 or UL 790
 Wind Driven Rain - TAS 100

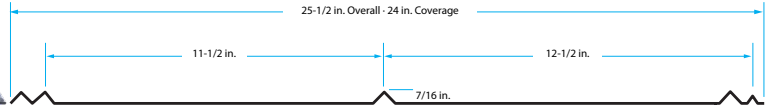

Stock Lengths Available in Mill Finish Only

Length	26 Gauge Galvalume	29 Gauge Galvanized	31 Gauge Galvanized
8 ft	13329	13351	99186
10 ft	13324	13340	99187
12 ft	13325	13343	99188
14 ft	13326	13345	99189
16 ft	13327	13347	99190

Made to Order Panels Availability

24 Gauge (PVDF & Mill Finish)	26 Gauge (SMP & Mill Finish)	29 Gauge (SMP & Mill Finish)
Yes	Yes	No

PVDF Colors - Made to Order



1 1/4" Corrugated Exposed fastener roofing panel. 24 inch width roofing coverage.
Applications: Residential, Agricultural, Architectural, Light Commercial, Industrial

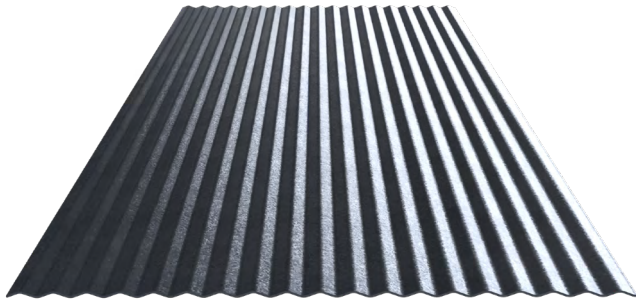

Code Approvals

UL Listing Directory #R20735

UL Fire Resistant Directory #R20735

Florida Building #FL-11175-R1

For the most recent code approval numbers, contact Southeastern Metals' Technical Department or refer to the appropriate code agency.

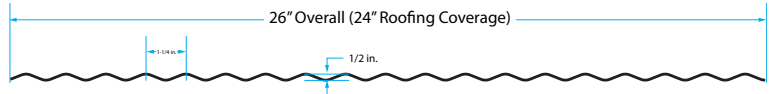

Stock Lengths Available in Mill Finish Only

Size	29ga Galvanized	31 Gauge Galvanized
8 ft.	13423	99191
10 ft	13412	99192
12 ft	13416	99193
14 ft	-	99194
16 ft	-	99195

Made to Order Panels Availability

24 Gauge (PVDF & Mill Finish)	26 Gauge (SMP & Mill Finish)	29 Gauge (SMP & Mill Finish)
Yes	Yes	No

SMP Colors - Made to Order



2 1/2 Corrugated Exposed fastener roofing panel. 21-1/2 inch width roofing coverage. 24 inch width siding coverage.
Applications: Residential, Agricultural, Architectural, Light Commercial, Industrial

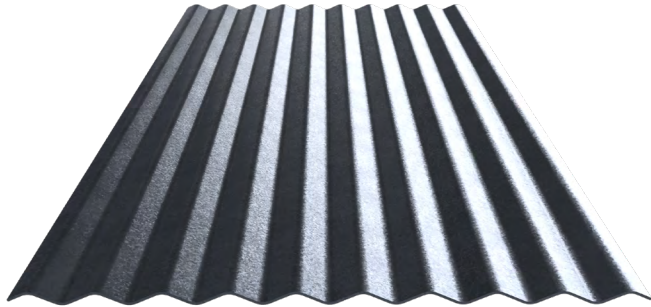

Code Approvals

UL Listing Directory #R20735

UL Fire Resistant Directory #R20735

Florida Building #FL-11175-R1

For the most recent code approval numbers, contact Southeastern Metals' Technical Department or refer to the appropriate code agency.

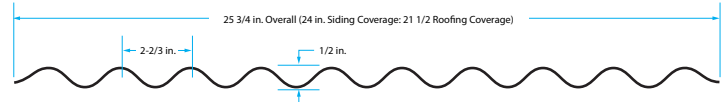

Stock Lengths Available in Mill Finish Only

Length	26 Gauge Galvanized	26 Gauge Galvalume	29 Gauge Galvanized	31 Gauge Galvanized
6 ft	-	-	-	13511
8 ft	13463	23988	13478	13513
10 ft	13458	23992	-	13504
12 ft	13459	23991	13474	13506

Made to Order Panels Availability

24 Gauge (PVDF & Mill Finish)	26 Gauge (SMP & Mill Finish)	29 Gauge (SMP & Mill Finish)
Yes	Yes	No

PVDF Colors - Made to Order



PBR Panel/R Panel Exposed fastener roofing panel. 36 inch width coverage. Applications: Residential, Agricultural, Architectural, Light Commercial, Industrial

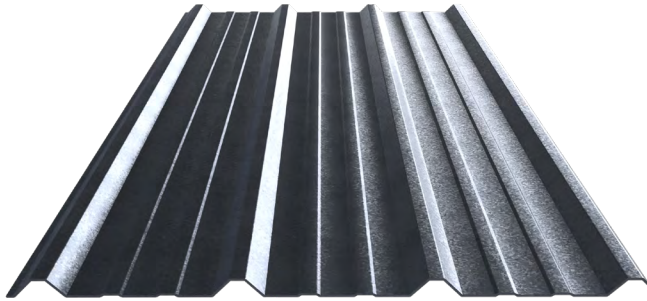

Code Approvals

UL Fire Resistant Directory #R20735
Florida Building #FL-11175

Testing Data & Specifications

Accelerated testing 2000 hours - ASTM G23
Salt Spray testing 1000 hours - ASTM B117
Fire Testing - ASTM E108 or UL 790
Wind Driven Rain - TAS 100



PBR Panel

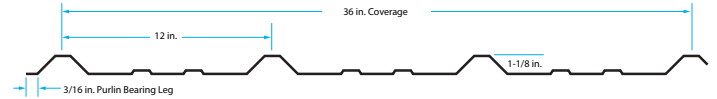

R Panel



Made to Order Panels Availability

Panel	24 Gauge (PVDF & Mill Finish)	26 Gauge (SMP & Mill Finish)	29 Gauge (SMP & Mill Finish)
PBR Panel	Yes	Yes	No
R Panel	Yes	Yes	Subject to Quote

SMP Colors - Made to Order



Sem-Lok™ Standing seam concealed fastener roofing panel. 16 inch width coverage. Applications: Residential, Agricultural, Light Commercial, Industrial

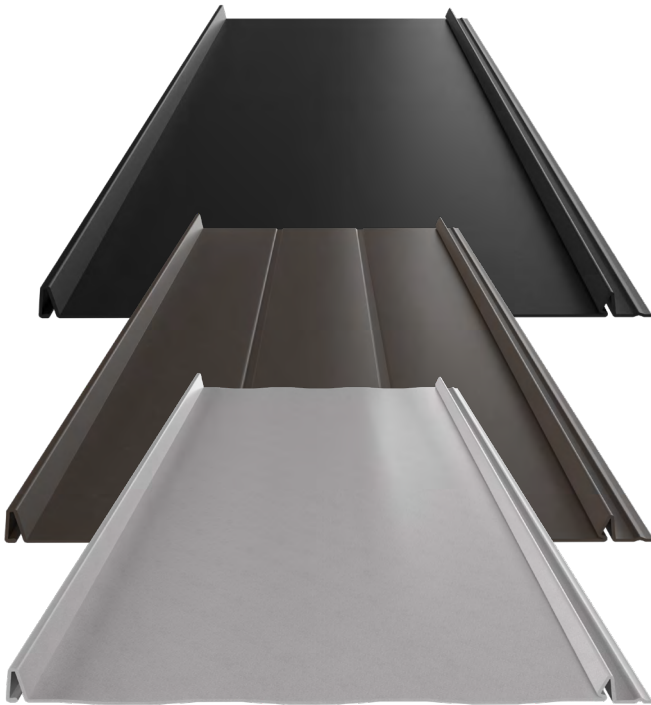

Code Approvals

UL Fire Resistant Directory #R20735
Miami Dade: N.O.A. No. 12-0229.02
Florida Building #FL-11175

Testing Data & Specifications

Accelerated testing 2000 hours - ASTM G23
Salt Spray testing 1000 hours - ASTM B117
Fire Testing - ASTM E108 or UL 790
Wind Driven Rain - TAS 100

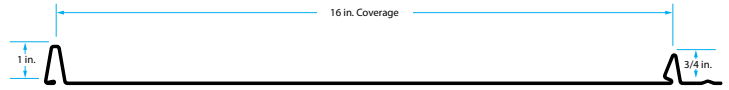

FLAT

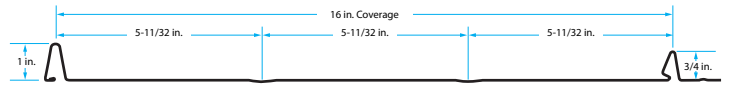

RIBBED

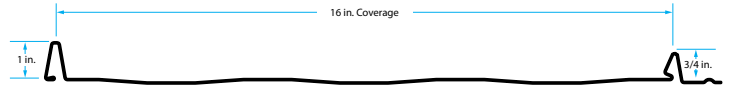

STRIATED

Made to Order Panels Availability

24 Gauge (PVDF & Mill Finish)	26 Gauge (SMP & Mill Finish)	29 Gauge (SMP & Mill Finish)
Yes	Yes	No

PVDF Colors - Made to Order



SM-Rib Exposed fastener roofing or siding panel. 36 inch width coverage Applications: Residential, Agricultural, Light Commercial, Industrial

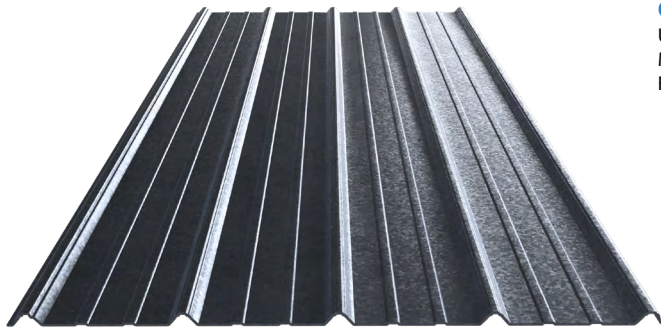

Code Approvals

UL Fire Resistant Directory #R20735
Miami Dade NOA #: 11-0714.08
Florida Building #FL-11175

Testing Data & Specifications

Accelerated testing 2000 hours - ASTM G23
Salt Spray testing 1000 hours - ASTM B117
Fire Testing - ASTM E108 or UL 790
Wind Driven Rain - TAS 100



Stock Lengths Available in Mill Finish Only

Length	29 Gauge Galvanized	29 Gauge Galvalume
8 ft	13560	70031
10 ft	13542	70032
12 ft	13544	70033
16 ft	-	70035

Made to Order Panels Availability

24 Gauge (PVDF & Mill Finish)	26 Gauge (SMP & Mill Finish)	29 Gauge (SMP & Mill Finish)
Yes	Yes	Yes

SMP Colors - Made to Order



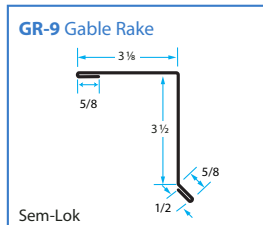
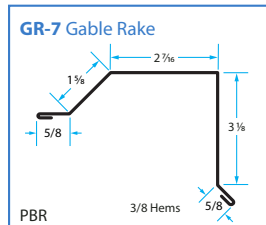
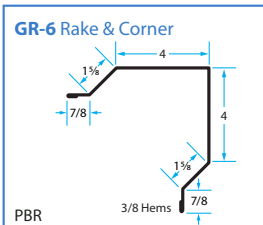
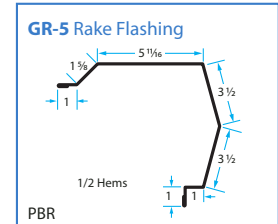
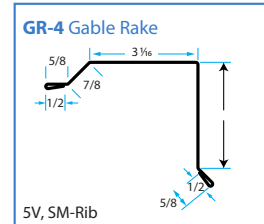
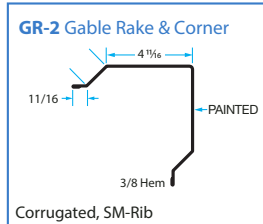
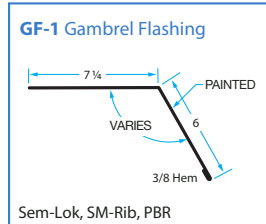
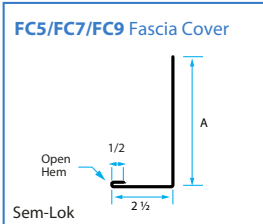
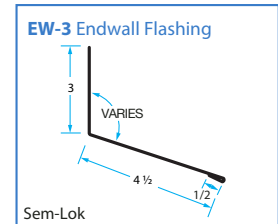
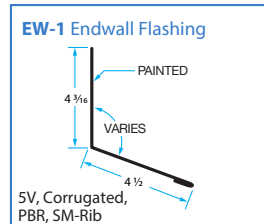
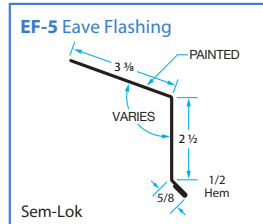
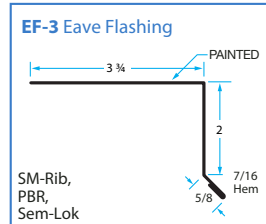
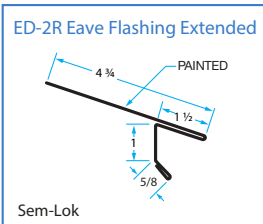
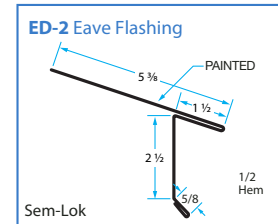
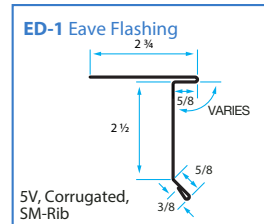
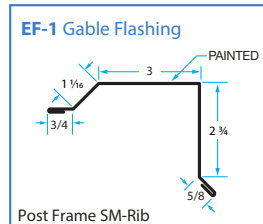
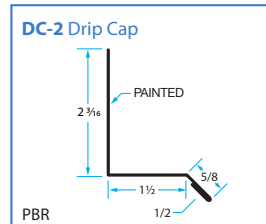
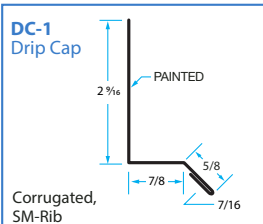
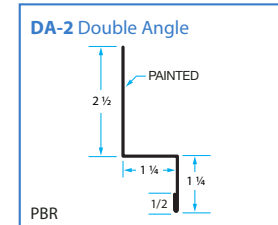
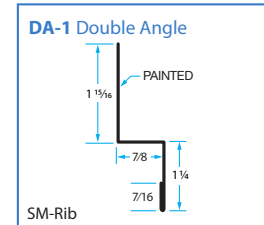
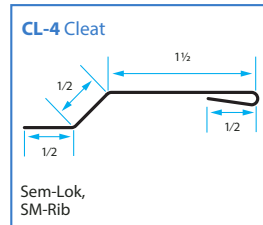
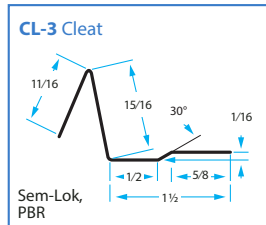
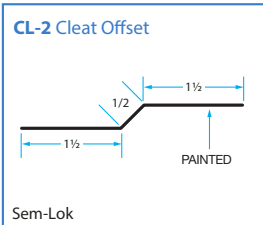
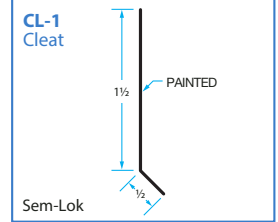
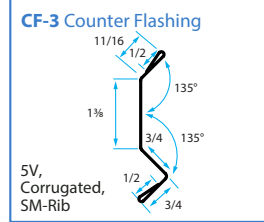
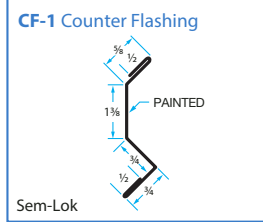
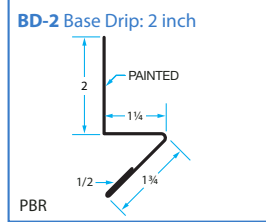
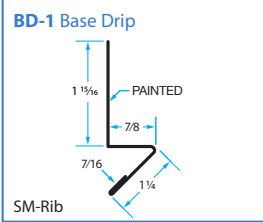

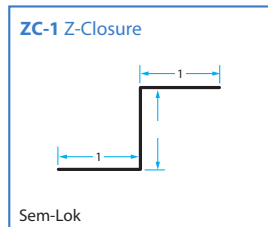
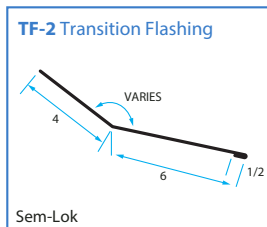
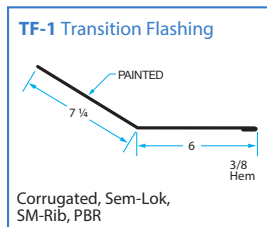
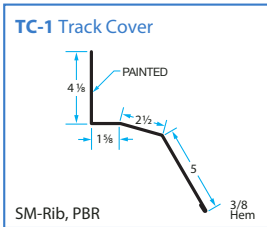
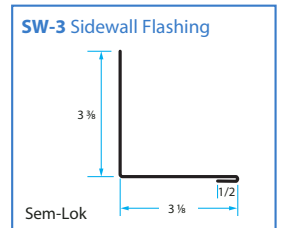
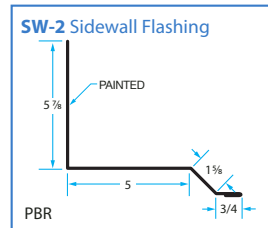
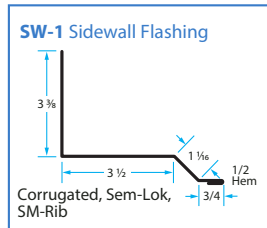
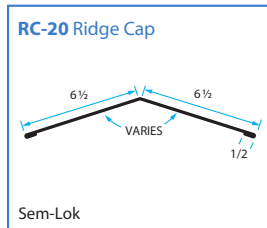
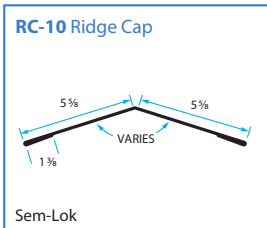
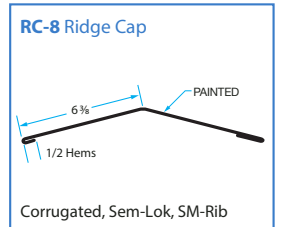
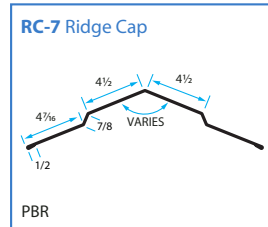
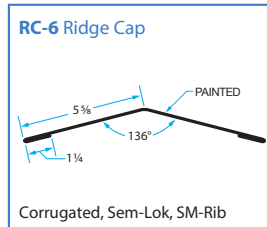
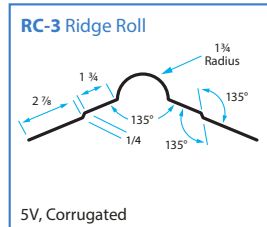
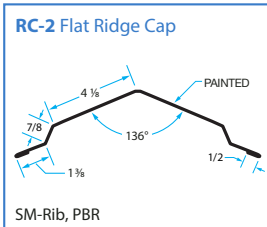
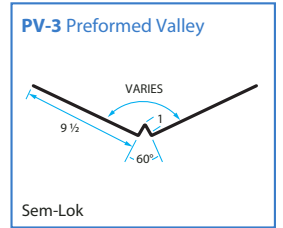
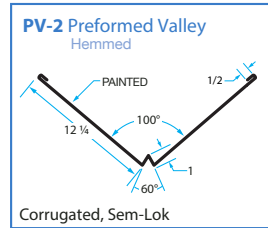
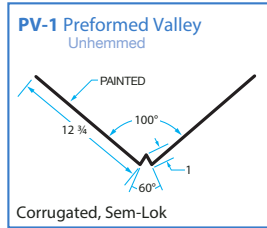
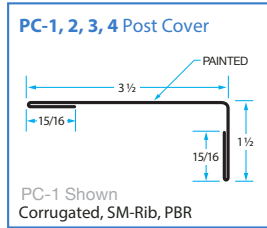
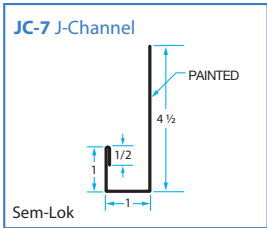
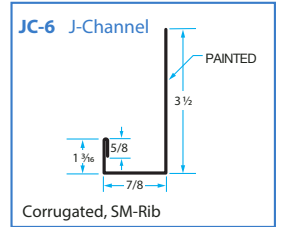
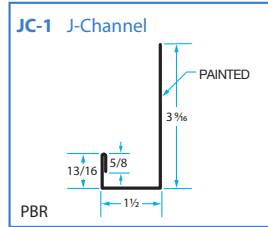
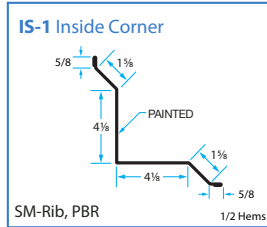
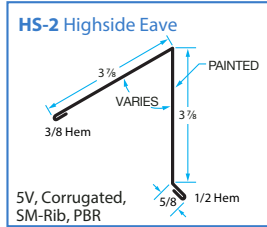
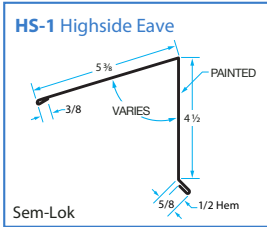

Flashing	5V Crimp	Corrugated	SM-Rib	SEM-Lok	PBR
BD-1 Base Drip					32716
BD-2 Base Drip: 2 inch			32731		
CF-1 Counter Flashing				32013	
CF-3 Counter Flashing	51323	51323			51323
CL-1 Cleat				32047	
CL-2 Cleat Offset				32081	
CL-3 Cleat			98870	98870	
DA-1 Double Angle			10726		10726
DA-2 Double Angle			32738		
DC-1 Drip Cap	03350	03350			03350
DC-2 Drip Cap			10830		
EF-1 Gable Flashing					32753
ED-1 Eave Flashing	32749	32749			32749
ED-2 Eave Flashing				32115	
ED-2R Eave Flashing Extended				32149	
EF-3 Eave Flashing	32757	32757	32757		32757
EF-5 Eave Flashing				32183	
EW-1 Endwall Flashing	32763	32763	32763		32763
EW-3 Endwall Flashing				32217	
FC 5 Fascia Cover	54596	54596		54596	54596
FC 7 Fascia Cover	54616	54616		54616	54616
FC 9 Fascia Cover	54636	54636		54636	54636
GF-1 Gambrel Flashing	32251	32251	32251	32251	32251
GR-1 Gable Rake & Corner	32941	32941			32941
GR-2 Gable Rake & Corner	32769	32769			32769
GR 4 Gable Rake	32276				
GR-5 Rake Flashing			12329		
GR-6 Rake & Corner			32786		
GR-7 Gable Rake			32789		
GR 9 Gable Rake				32285	
GR 9R Gable Rake				32319	
HS-1 Highside Eave				32353	
HS-2 Highside Eave	23298	23298	23298		23298
IS-1 Inside Corner			32792		32792
JC-1 J-Channel			32795		
JC-4 J-Channel	33054	33054			33054
JC-6 J-Channel	33117	33117			33117
JC-7 J-Channel				32387	
PC-1 Post Cover					32801
PC-2 Post Cover					32804
PC-3 Post Cover					32808
PC-4 Post Cover					32811

Flashing	5V Crimp	Corrugated	SM-Rib	SEM-Lok	PBR
PV-1 Preformed Valley, Unhemmed	32814	32814	32814		32814
PV-2 Preformed Valley, Hemmed	32895	32895	32895		32895
PV 3 Preformed Valley				32421	
RC-1 Ridge Cap	32817	32817			32817
RC-2 Flat Ridge Cap		32820			32820
RC 3 Ridge Roll	32823	32823			
RC-6 Ridge Cap	31778	31778	31778		31778
RC-7 Ridge Cap			32827		
RC-8 Ridge Cap	32832	32832	32832		32832
RC-10 Ridge Cap				32455	
RC-20 Ridge Cap				32849	
RF 1 Reglet Flashing				32523	
SR 1 Step Rake				32557	
SW-1 Sidewall Flashing	32835	32835	32835		32835
SW-2 Sidewall Flashing			32838		
SW-3 Sidewall Flashing				32591	
SW-4 Sidewall Flashing				32651	
TC-1 Track Cover			32844		32844
TF-1 Transition Flashing	32841	32841	32841		32841
TF-2 Transition Flashing				32659	
ZC-1 Z Closure				32693	

Ridge Roll Flashing

For hip and ridge roof sections.

For shingle or metal roof applications. Pack Quantity: 10

Description	Plain	Corrugated
10 in. x 10 ft. Galvanized Steel Ridge Roll	15648	15636
12 in. x 10 ft. Galvanized Steel Ridge Roll	15652	-

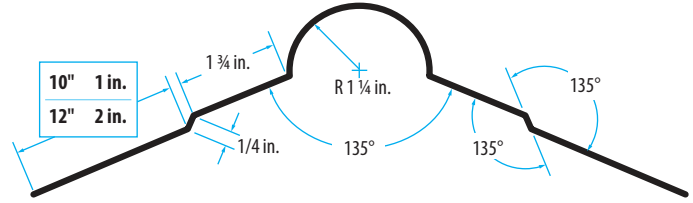

Closure Strips

Closure strips fill the gap between the roofing panel and the roof deck to keep out insects, vermin and wind-blown rain.

Foam closure strips have a self-adhesive backing for ease of installation.

4 strips per bag · Pack Quantity: 25 bags

Description	Part #
2.5" Corrugated Closure Strips	53665
5V Crimp - Inside Closure Strips	53663
5V Crimp - Outside Closure Strips	53664
SM-Rib - Inside Closure Strips	53666
SM-Rib - Outside Closure Strips	53667
PBR/R - Inside Closure Strips	53668
PBR/R - Outside Closure Strips	53669

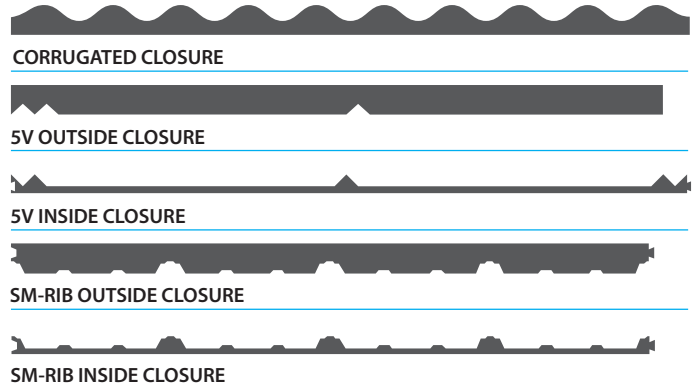

Woodfast Screws

Galvanized #9 Hex-Head with integrated neoprene gasket and self-piercing tip.

Description	100/bag
#10 x 1-1/2 in. Woodfast Screws	34404
SCREW W GZ #10 1 1/2" WHITE 250/BG	987682
SCREW W GZ #10 1 1/2" RED 250/BG	34156
SCREW W GZ #10 1 1/2" GREEN 250/BG	34165
SCREW W GZ #10 1 1/2" GRAY 250/BG	34173



Butyl Tape

Sealant commonly used in metal roofing installations to seal metal-to-metal connections. Stays flexible over time providing an effective barrier against moisture.

Description	Part #	QTY
1/2 in. x 50 ft. Rolls	99415	20 Rolls



Pipe Boots

Description	Part #
#3 Round Base BLK EPDM	53657
#3 Round Base GRY EPDM	53658
#5 Round Base BLK EPDM	53659
#5 Round Base GRY EPDM	53660
#8 Round Base BLK EPDM	53661
#8 Round Base GRY EPDM	53662

Metal Roof Sealant

Description	Part #
Clear	53710
Black	53711
Gray	53712
White	53713

Coil

All coils 1000-1200 pounds each

Gauge	Finish	Sizing
26	SMP Paint System	Up to 20.50"
26	Mill Finish Galvalume	Up to 20.50"
24	PVDF Paint System	Up to 23.9375"
24	Mill Finish Galvalume	Up to 23.9375"

Submit a request for quote via our website

<https://gibraltarbldgproducts.com/metal-roofing-request-for-quote-form>



Flat Sheet Items

Sold per sheet with job packs

Sold per bundle of 50 sheets for stock

Gauge	Finish	Sizing
26	SMP Paint System	41.5625" x 120"
26	Mill Finish Galvalume	41.5625" x 120"
24	PVDF Paint System	43" x 120"
24	Mill Finish Galvalume	43" x 120"
24	PVDF Paint System	48.375" x 120"
24	Mill Finish Galvalume	48.375" x 120"

Submit a request for quote via our website

<https://gibraltarbldgproducts.com/metal-roofing-request-for-quote-form>



PVDF Colors - Coil & Flat Sheet Offerings



SMP Colors - Coil & Flat Sheet Offerings

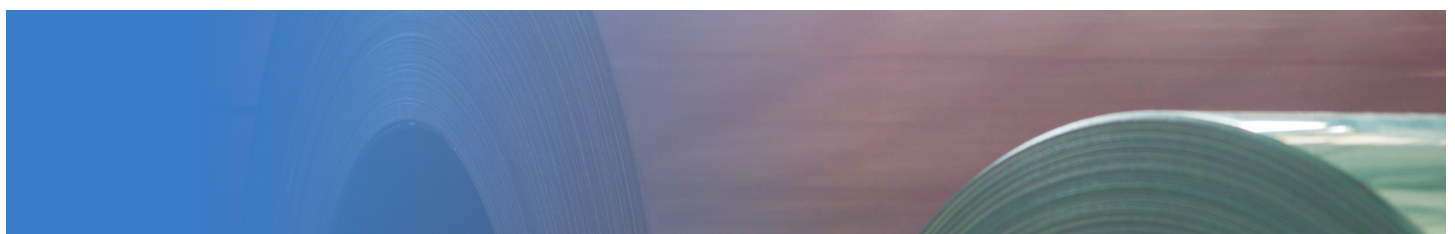

Angle Flashing protects against moisture infiltration at roof-to-wall and chimney intersections. 10 ft. Lengths · 25 pieces per bundle

Galvanized Angle Flashing

Size - A x B	ST Gauge	26 Gauge
4 in. x 4 in.	10168	-
4 in. x 5 in.	-	10110
5 in. x 5 in.	10196	10118
5 in. x 7 in.	-	10126
6 in. x 6 in.	-	10128

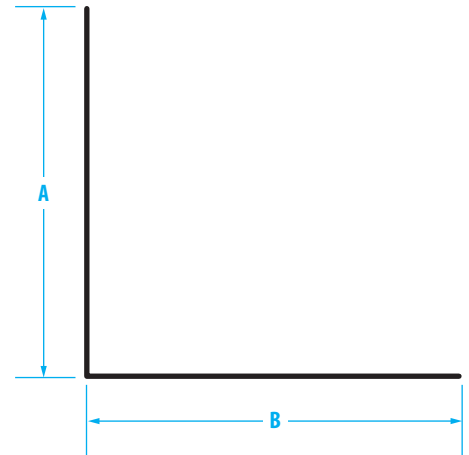

Galvalume Angle Flashing - 26 Gauge

Size - A x B	Part #
4 in. x 5 in.	23167
4 in. x 6 in.	23352
5 in. x 7 in.	40266

Aluminum Angle Flashing

Size - A x B	Description	Part #
5 in. x 5 in.	0.032 Aluminum	10084

Hemmed Galvanized Angle Flashing - 1/2 in. Hem

Size - A x B	ST Gauge	HT Gauge	26 Gauge
4 in. x 3-1/2 in.	-	10177	10102
4 in. x 4 in.	10170	-	10106
5 in. x 4-1/2 in.	-	-	10122
5 in. x 5 in.	10198	-	-
6 in. x 5-1/2 in.	10212	-	10130

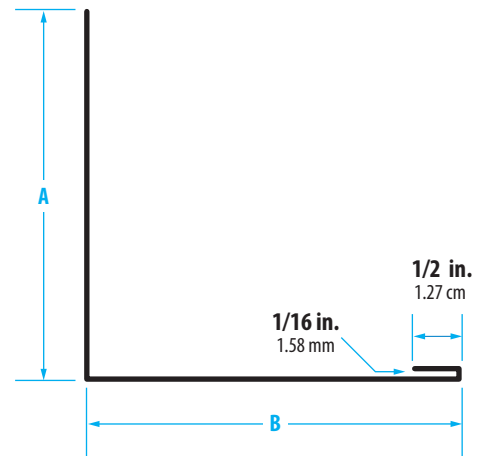

Painted Galvanized Angle Flashing

Size - A x B	Description	Part #
4 in. x 4 in.	ST Gauge Galvanized - Black	50084
4 in. x 4 in.	ST Gauge Galvanized - Brown	50085
5 in x 5 in	26 Gauge Galvanized - Black	12019
5 in x 5 in	26 Gauge Galvanized - Brown	12021

Painted Galvanized Angle Flashing - 1/2 in. Hem

Size - A x B	Description	Part #
4 in x 9 in	26 Gauge Galvanized - Black	10221
4 in. x 3-1/2 in.	ST Gauge Galvanized - Black	10125

Apron/Dormer Flashing protects roofing from water damage at Roof-to-Wall connections and dormers. 10 ft. Lengths · 20 Pieces per bundle

Apron/Dormer Flashing - Mill Finish

Description	Part #
4-5/16 in. x 2-3/4 in. - ST Gauge - 7 1/2	11905
4-5/16 in. x 2-3/4 in. - 26 Gauge - 7 1/2	11889
4-5/16 in. x 3-1/4 in. - ST Gauge - 8	10866

Apron/Dormer Flashing - Painted

Description	Brown	Black
4-5/16 in. x 4-1/4 in. ST Gauge 9 in.	11925	98261

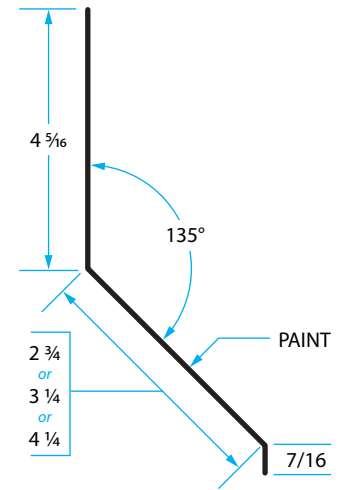

Bullet Boot is a one piece flexible rubber flashing that installs directly over standard PVC vent pipes.

Size	Black	Brown	White	Gray	Weathered Wood	QTY
1 1/2 in.	23221	23220	23222	23223	23236	16
2 in.	23225	23224	23226	23227	23237	16
3 in.	23229	23228	23230	23231	23238	16
4 in.	23233	23232	-	-	23239	8



Bullet Boot Colors

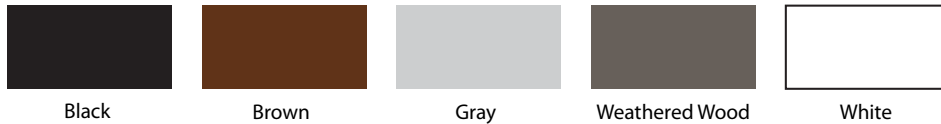

Roof Edge Applied to the eave and rake to direct water away from the structure. 10 ft. Lengths · 10 Pieces per bundle

Galvanized Roof Edge

Known As	SEMCO's Description	26 Gauge	ST Gauge	HT Gauge	Pieces/Carton	Cartons/Pallet
1-1/2 in. x 1-1/2 in.	Roof Edge 3 in x 1-1/2 in F	-		15539	25	1250
2 in x 2 in.	Roof Edge 4 in x 2 in F	15431	15541-	-	25	500
2-1/2 in. x 2-1/2 in.	Roof Edge 5 in x 2-1/2 in F	15453	-	-	25	500
3 in x 2 in	Roof Edge 5 in x 2 in F	50021	-	-	25	500
3 in x 3 in	Roof Edge 6 in x 3 in F	15455	15553	-	25	500
4 in x 2 in	Roof Edge 6 in x 2 in F	15459	15555	-	25	500
4 in x 4 in	Roof Edge 8 in x 4 in F	-	15562	-	25	500

Description	"A"	"B"
	1-1/4 in	1-1/2 in
4 in x 2 in	1-3/4 in	2 in
5 in x 2-1/2 in	2-1/4 in	2-1/2 in
5 in x 2 in	2-3/4 in	2 in
6 in x 3 in	2-3/4 in	3 in
6 in x 2 in	3-3/4 in	2 in
8 in x 4 in	3-3/4 in	4 in
4-1/2 in x 2-1/2 in	1-5/8 in	2-1/2 in

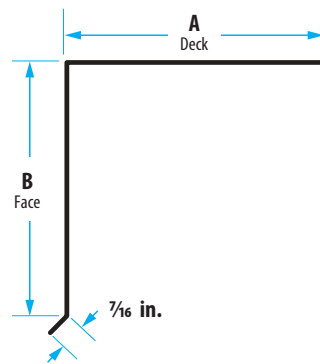

Galvalume Roof Edge

Known As	SEMCO's Description	26 Gauge	Pieces/Carton	Cartons/Pallet
2 in x 2 in 26 Gauge	Roof Edge GM 26 4 in x 2 in F	15439	25	500
3 in x 3 in 26 Gauge	Roof Edge GM 26 6 in x 3 in F	15463	25	500

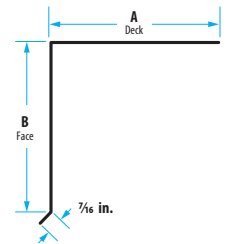

Painted Roof Edge

Known As	SEMCO's Description	White	Brown	Black	Pcs/Ctn	Ctn/Pal
2 in x 2 in ST Gauge Galvanized	Roof Edge GZ ST 4 in x 2 F	15587	-	-	25	500
2 in x 2 in 26 Gauge Galvanized	Roof Edge GZ 26 4 in x 2 in F	15591	50050	-	25	500
2 in x 2-1/2 in 26 Gauge Galvanized	Roof Edge GZ 26 4-1/2 in x 2-1/2 in F	15589	-	-	25	500
3 in x 3 in ST Gauge Galvanized	Roof Edge GZ ST 6 in x 3 in F	15593	-	-	25	500
3 in x 3 in 26 Gauge Galvanized	Roof Edge GZ 26 6 in x 3 in F	155595	15507	15505	25	500
4 in x 2 in ST Gauge Galvanized	Roof Edge GZ ST 6 in x 2 in F	99019	-	-	25	500
3 in x 3 in .025 Aluminum	Roof Edge AL .025 6 in x 3 in F	50058	-	-	25	500

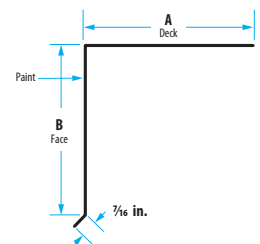

Hemmed and Ribbed Roof Edge

Known As	SEMCO's Description	White	Brown	Black	Pcs/Ctn	Ctn/Pal
4 in x 2 in ST Gauge Galvanized	Roof Edge GZ ST 6 in x 2 in F	50076	50074	50075	25	500
4 in x 2 in .017 Aluminum	Roof Edge AL .017 6 in x 2 in F	50071	50073	50072	25	700

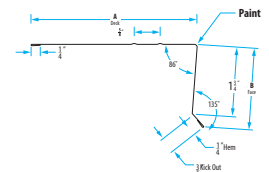

Eave Drip Applied to the eave and rake to support shingles and direct water away from the structure. 10 ft. Lengths

Galvanized Eave Drip

Size: A x B	26 Gauge	ST Gauge	HT Gauge
1-1/2 in. x 1 in. with 1/2 in. OH	-	-	11330
1-5/8 in. x 1-1/4 in.	-	11316	18612
1-3/4 in. x 1-1/8 in.	-	11324	11322
1-11/16 in. x 1-1/4 in.	11020	-	-
2 in. x 1-1/2 in.	-	11340	-
2-1/16 in. x 1-1/2 in.	11040	-	-
2-3/4 in. x 1-3/4 in.	-	11356	-
2-13/16 in. x 1-3/4 in.	11056	-	-
2-1/16 in. x 2-1/2 in.	11048	-	-
3-3/8 in. x 1-1/8 in.	-	11358	-

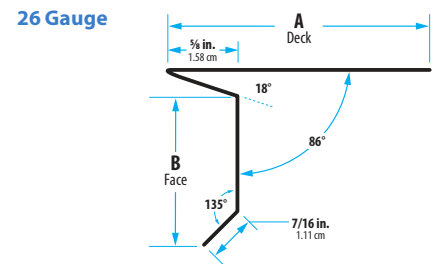
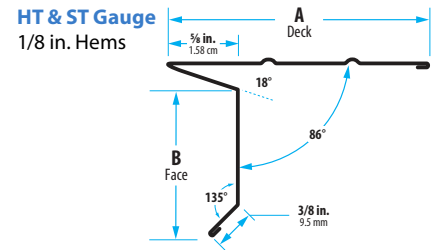

Painted Galvanized Eave Drip - ST Gauge

Size: A x B	Black	Brown	W'Wood	White
1-5/8 in. x 1-1/4 in.	11256	11220	-	11419
1-3/4 in. x 1-1/8 in.	-	-	-	11430
2 in. x 1-1/4 in.	-	-	11259	-
2 in. x 1-1/2 in.	-	-	-	11436
2-3/4 in. x 1-3/4 in.	-	11240	-	11448
3-3/8 in. x 1-1/8 in.	11266	11238	-	11446
5 in x 1-1/2 in	11231	11230	-	-

Painted Galvanized Eave Drip - 26 Gauge

Size: A x B	Black	Beige	Brown	Gray	White	W'Wood
1-11/16 in. x 1-1/4 in.	-	-	-	-	11426	-
2-1/16 in. x 1-1/2 in.	11213	-	11232	-	11442	-
2-1/16 in. x 2-1/2 in.	11264	11214	11244	11290	11454	11059
2-13/16 in. x 1-3/4 in.	-	-	-	-	11054	-
3-7/16 in x 1-1/8 in	11270	-	11279	-	11287	-
3-1/16 in. x 1-1/2 in.	-	99489	11050	-	11052	-

Galvalume Eave Drip - 26 Gauge

Size: A x B	Mill
2-1/16 in. x 2-1/2 in.	11062



Aluminum Eave Drip - ST Gauge

Size: A x B	Mill	Black	Brown	Clay	White	Weatherwood
1-1/2 in. x 1 in.	11294	-	11168	11274	11368	-
1-5/8 in. x 1-1/4 in.	11296	11250	11170	-	11370	-
2 in. x 1-1/2 in.	-	11889	11188	11276	11390	-
2 in. x 2-1/2 in.	-	-	-	-	11396	-
2-3/8 in. x 1-1/8 in.	-	52003	52002	-	52001	-
2-3/4 in. x 1-3/4 in.	-	11405	-	-	11402	-
3-3/8 in. x 1-1/8 in.	-	99540	99539	99054	99534	-
5 in. x 1-1/2 in.*	-	-	-	-	29998	-
6 in. x 2-1/2 in.*	-	-	11196	-	11398	-
8 in. X 1 in.**	-	52013	52012	-	52011	52014

*.025 **.0118

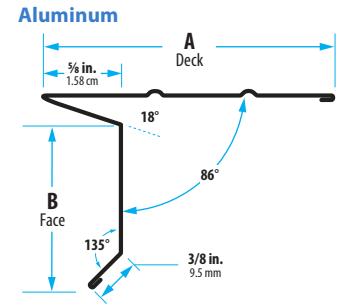

Formed Valley Used in open valley installations to protect against water infiltration. 10 ft. lengths, 1 pc per bundle and 100 pcs per pallet

18 in. Valley

Description	Mill
18 in. - Hemmed	12037

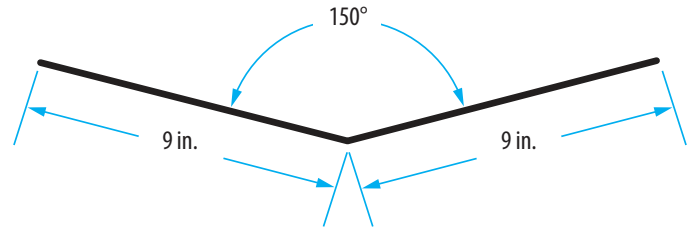

Pre-Formed 18 in. W-Valley

Description	Mill	Black	Brown
18 in. - ST Gauge - Hemmed	-	14896	-
18 in. - 26 Gauge - Hemmed	14868	14897	99175

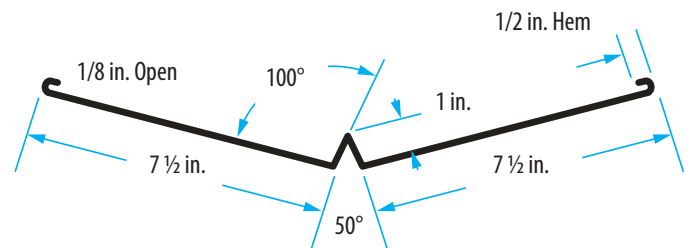

Pre-Formed 24 in. W-Valley

Description	Mill
24 in. - 26 Gauge Galvalume	32862



Ridge Roll Flashing for hip and ridge roof sections. For shingle or metal roofing applications. 10 ft. lengths, 10 pieces per bundle

Description	Galvanized - ST Ga.	Pallet QTY
10 in. Ridge Roll	15648	250
12 in. Ridge Roll	15652	250
14 in. Ridge Roll	15654	250
10 in. Ridge Roll - 2-1/2 in. Corrugated	15636	500

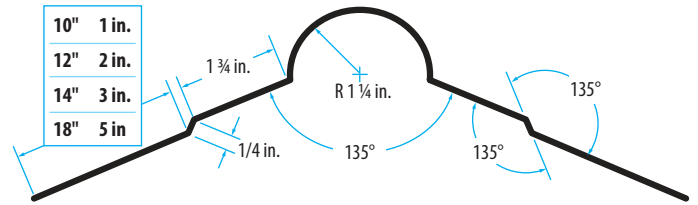

Water Diverter Directs rain water run-off away from entrances and other structures. Galvanized Steel. • 10 ft. lengths

Description	Mill	Black	Brown	Carton QTY
5 in. Water Diverter - 26 Gauge - 7 1/2	17676	-	-	10
5 in. Water Diverter - ST Gauge - 7 1/2	17690	17684	17688	20

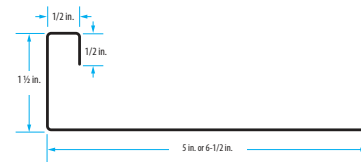

Stucco Flashing Used as a stucco stop to separate wallboard siding or stucco. 25 pieces per carton, 500 pieces per pallet

Description	26 Ga. Galvanized	26 Ga. Galvalume
Stucco Flashing	16017	99340
Stucco Flashing + Extra Bend	16019	99341

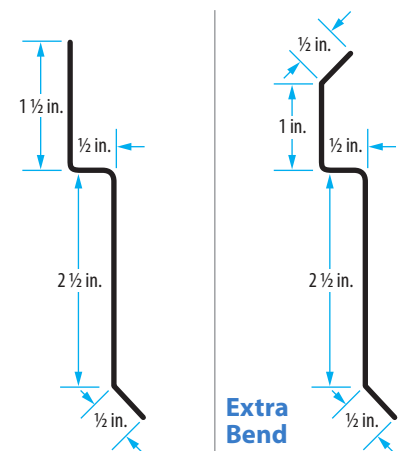

Z-Flashing Protects top edge of siding sheets from water infiltration. 10 ft. lengths • 50 pieces per bundle

Size: A x B x C	ST Galvanized	HT Galvanized	26 Ga. Galvanized	26 Ga. Galvalume
2 in. x 3/8 in. x 5/8 in.	-	17837	-	-
2 in. x 5/8 in. x 3/8 in.	-	17845	17807	17808
1/2 in x 3/8 in x 1-1/2 in	17804	-	-	-

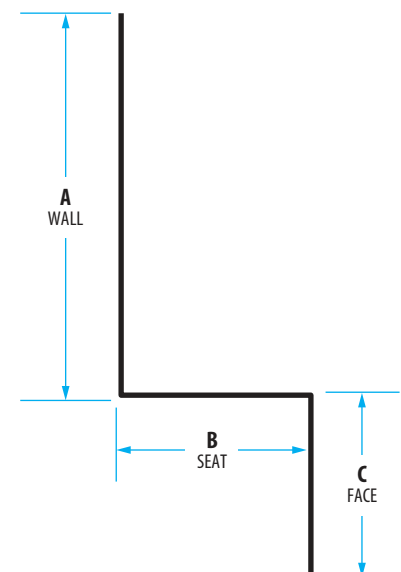

Step Flashing Step flashing is installed where shingled roofing meets the vertical wall or chimney. 100 pieces per carton, 10,000 pieces per pallet

Aluminum Step Flashing

Description	EC Gauge	ST Gauge
Flat - 5 in. x 7 in. - Mill	-	11956
3 in. x 4 in. x 7 in. Mill	11984	-
3 in. x 4 in. x 7 in. - Black	98225	-

Step Flashing - CONTRACTOR PACKS

Description	Gavlanized	Aluminum	Pallet QTY
3 in. x 4 in. x 7 in. - EC Gauge Aluminum - Black	-	99431	10,000
4 in. x 2 in. x 8 in. - HT Gauge Galvanized- Black	11993	-	-
4 in. x 4 in. x 8 in. - EC Gauge Aluminum - Black	-	44800	10,000
4 in. x 4 in. x 8 in. - ST Gauge Aluminum - Brown	-	44801	10,000
4 in. x 4 in. x 8 in. - HT Gauge Galvanized- Mill	99162	-	10,000
5 in. x 5 in. x 8 in. - ST Gauge Aluminum - Mill	-	99206	10,000

Galvanized Steel Step Flashing

Description	HT Gauge
2 in. x 3 in. x 7 in. - Mill	11998
3 in. x 4 in. x 7 in. - Mill	12008
4 in. x 4 in. x 7 in. - Mill	12016
4 in. x 4 in. x 8 in. - Mill	12020

Painted Galvanized Steel Step Flashing

Description	ST Gauge
4 in. x 4 in. x 8 in. - Black	11997
4 in. x 4 in. x 8 in. - Weather Wood	18912

Flat Sheet Metal is available in various thicknesses and widths and can be used as a flashing or for DIY projects 1 piece per carton, 1,000 pieces per pallet

Galvanized Steel Flat Sheets

Description	Part #
27.5 in. x 10 ft. - 26 Gauge - Mill	70020
36 in. x 4 ft. - 26 Gauge - Mill	16287
48 in. x 10 ft. - 26 Gauge - Mill	16303

Galvalume Flat Sheets

Description	Part #
27.5 in. x 10 ft. - 26 Gauge - Mill	16271
27.5 in. x 10 ft. - 24 Gauge - Mill	16251
42 in. x 10 ft. - 26 Gauge - Mill	16342
42 in. x 10 ft. - 24 Gauge - Mill	16253
48 in. x 10 ft. - 26 Gauge - Mill	16341

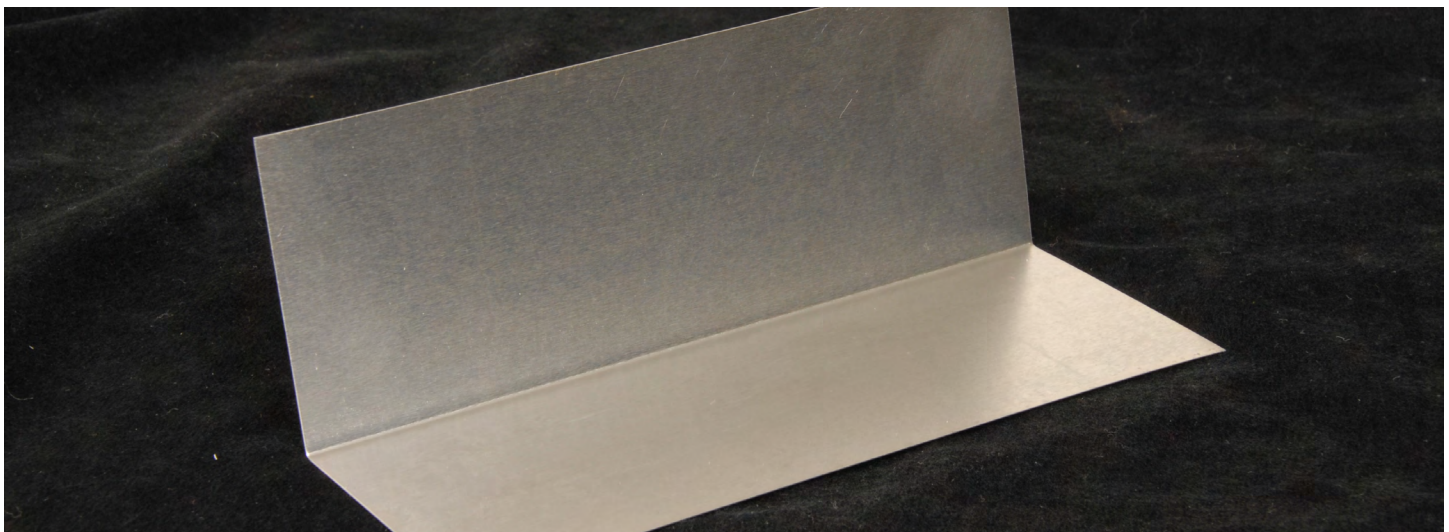

Roll Flashing Multi-use product for fabricating flashings and many other do-it-yourself projects. Rolls sold individually.

Galvanized Roll Flashing

Description	HT Gauge	26 Gauge
6 in. x 10 ft.	17472	-
8 in. x 50 ft.	17479	-
10 in. x 10 ft.	17404	-
10 in. x 50 ft.	17403	-
12 in. x 50 ft.	17412	-
14 in. x 10 ft.	17420	-
14 in. x 50 ft.	17419	-
16 in. x 25 ft.	-	17232
16 in. x 50 ft.	17425	17222
18 in. x 50 ft.	17431	-
20 in. x 10 ft.	17439	-
20 in. x 25 ft.	17441	-
20 in. x 50 ft.	17438	-
24 in. x 25 ft.	17449	-
24 in. x 50 ft.	17446	-

Aluminum Roll Flashing - EC Gauge

Description	Part#
8 in. x 50 ft.	17390
10 in. x 10 ft.	17275
10 in. x 50 ft.	17208
12 in. x 50 ft.	17290
14 in. x 10 ft.	17306
14 in. x 50 ft.	17210
16 in. x 50 ft.	17318
20 in. x 10 ft.	17339
20 in. x 50 ft.	17212
24 in. x 50 ft.	17352
16 in. x 50 ft. - 0.024	20766

Painted Aluminum Roll Flashing

Description	Color	Part#
10 in. x 10 ft. - 0.013	White/Brown	17191
10 in. x 50 ft. - EC	Black	98223

Galvalume Roll Flashing - 26 Gauge

Description	Part#
16 in. x 50 ft.	60000

Tile Accessories

Tile Runner 26 Gauge Aluminum Zinc Alloy Coated Steel, Mill Finish

Height	Part #
3"	3BHR263
3.5"	3BHR2635
4"	3BHR264
5"	3BHR265
6"	3HR266
7"	3BHR267

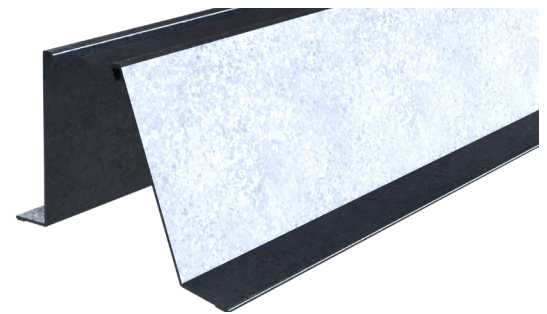

Tile Closure 26 Gauge · 10' Length

Color	Flat	Capistrano	Malibu	Barcelona	Villa 900
White	55389	55394	55399	55404	55409
Black	55390	55395	55400	55405	55410
Brown	55391	55396	55401	55406	55411
Bronze	55392	55397	55402	55407	55412
Dark Bronze Metallic	55393	55398	55403	55408	55413



Gooseneck Vents

Sheltered internal air dampers provides one-way air venting with damper. Often used for kitchen or bath exhaust. Self flashing flanges make for easy installation on new or existing construction.

Description - Shingle Roof Only	Mill	White	Brown	Black	N.F.A.	QTY
4 in. - 26 Gauge Galvanized Steel	-	17640	17592	60027	12	12
10 in. 26 Gauge Galvanized Steel	22999	17644	17596	17605	30	6

Description	Shingle	QTY	N.F.A.	Tile	QTY
4 in. - 26 Gauge Galvalume Steel	60011	12	12	60566	6
6 in. - 26 Gauge Galvalume Steel	60635	6	18	98302	4
10 in. - 26 Gauge Galvalume Steel	60010	6	30	98301	4



One-way air venting damper

Weather Vent™

Patterned 4 foot Off Ridge Vent includes a screened external wind baffle provides superior air flow with maximum weather protection. U.S. Patent Number: 7,044,852 B2

Length	Galvanized	Galvalume	White	Brown	Black	N.F.A.	QTY
4 foot - 26 Gauge	63000	60014	63003	63002	63001	105	1
6 foot - 26 Gauge	-	-	-	17594	17603	156	2
8 foot - 26 Gauge	-	-	-	-	17604	207	2

Length	26 Gauge Galvalume	N.F.A.	QTY
Tile: 4 foot - With Baffle	63130	105	1
Tile: 4 foot - Without Baffle	60094	105	1
Tile: 8 foot - Without Baffle	60028	225	2
Baffle: 4' tile Vent	60626	-	10

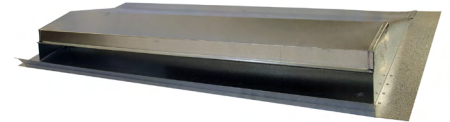

Total JACK™ The only roof jack with an adjustable stack and base. Adjusts to fit most roof pitches.

Size	Mill	Black	Brown	Weathered Wood	QTY
6 inch	JACK6GZ	JACK6BLK	JACK6BRN	JACK6WWD	7
8 inch	JACK8GZ	JACK8BLK	JACK8BRN	JACK8WWD	6

KEEPING?



Galvanized steel in accordance to ASTM A924/A653



Universal Ridge Vent

Removes superheated attic air. Self-flashing. Can be installed on new or existing construction. Embossed Aluminum. 10 ft. lengths.

Description	Black	Brown	Gray	White	QTY
10 ft. Universal Ridge Vent	84403	84405	84402	84399	12
End Plug/Connector - Rubber	84426	-	-	-	12
End Plug/Connector - Foam	40237	-	-	-	24



Roof Jack

Description	Mill	QTY
5" Flat	17515	10
5" Pitch	17517	10

Soffit

Description	Aspen White	Black	Florida Bronze	Musket Brown	CTN QTY
12" 3-Panel Fully Vented Soffit	120013	-	-	-	20
12" 3-Panel Solid Soffit	120014	-	-	-	20
16" 4-Panel Fully Vented Soffit	120015	120017	120019	120021	20
16" 4-Panel Solid Soffit	120016	120018	120020	120022	20

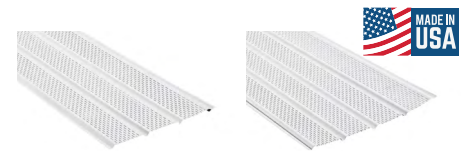

J-Bead

A channel-type trim that provides a neat protective edge for wallboard at windows and doors. Widely used as a terminal at intersections of wallboard and other surfaces

Description	Part #	Carton	Pallet
1/2 in. x 10 ft. - Galvanized Steel J-Bead	12839	50	2,450
1/2 in. x 10 ft. - Vinyl J-Bead	70084	50	2,400
5/8 in. x 10 ft. - Vinyl J-Bead	70083	50	2,400

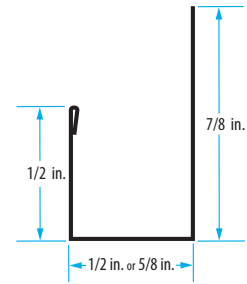

L-Bead

A angle-type trim provides a finished appearance for wallboard edges at door and window openings. Hemmed edge. Nailing flange is knurled and perforated to aid compound adhesion

Description	Part #	Carton	Pallet
1/2 in. x 10 ft. - Vinyl L-Bead	70085	80	3,840
1/2 in. x 10 ft. - Galvanized Steel L-Bead	13039	50	2,400

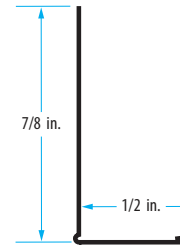

Corner Bead

Strong, durable and straight reinforcement for drywall and veneer plaster corners.

Description	Part #	Carton	Pallet
1-1/4 in. x 8 ft. - Vinyl Corner Bead	10518	50	2,500
1-1/4 in. x 10 ft. - Vinyl Corner Bead	10512	50	2,500
1-1/4 in. x 8 ft. - Galvanized Steel Corner Bead	10530	63	3,087
1-1/4 in. x 9 ft. - Galvanized Steel Corner Bead	10532	56	2,744
1-1/4 in. x 10 ft. - Galvanized Steel Corner Bead	10524	50	2,450
8 ft. - Superwide Paper-Faced Corner Bead	70086	50	2,800
10 ft. - Superwide Paper-Faced Corner Bead	70087	50	2,800
10 ft. - Superwide Paper-Faced Inside Corner	70088	50	2,800
1/2 in. x 10 ft. Vinyl Zip Corner Bead	70082	50	2,400

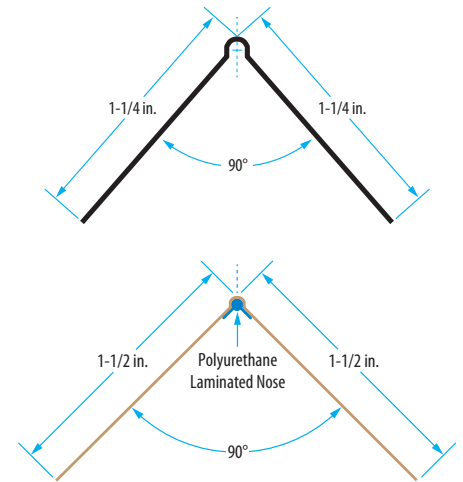

big-stick

Bullnose Corner Bead

Provides an architecturally attractive corner that is both durable and straight on exposed edges of wallboard.

Description	Part #	Carton	Pallet
10 ft. - Vinyl Bullnose Corner Bead	10514	35	1,750
10 ft. - Galvanized Steel Corner Bead	10505	40	1,600

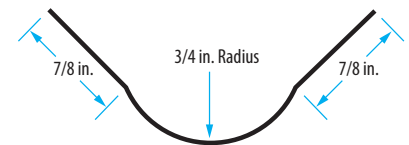

Arched Vinyl Corner Bead

Pre-notched to form curves easily. Improved slots for better radius.

Description	Part #	Carton	Pallet
1-1/4 in. x 10 ft. - Arched Vinyl Corner Bead	10513	50	2500
10 ft. - Arched Vinyl Bullnose Corner Bead	70081	50	1750

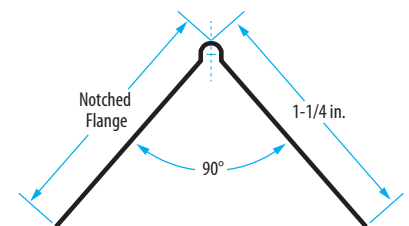

H-Moulding

Used to splice butt joints of plywood soffit systems. Material: Aluminum Extrusion

Description	Part #	QTY.
3/8 in. x 12 ft. Aluminum H-Moulding	12754	50

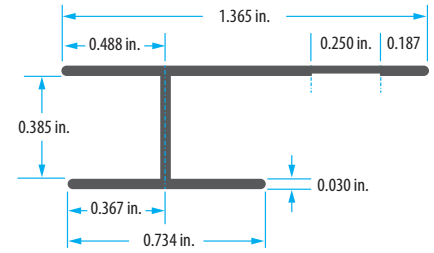

Termite Shield

Provides a moisture & termite barrier for wood sill-to-concrete contact.

Description	Gauge	Part #	Bundle
4 in. x 2 in. x 10 ft. - Termite Shield	28	17049	20
8 in. x 2 in. x 10 ft. - Termite Shield	ST	17043	20

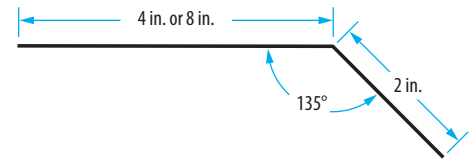

Casing Bead

Creates a flush stucco stop for framed doors, windows, and other openings. A ridge of nail holes provides for easy installation.

Description	Part#	Carton	Pallet
1/2 in. x 10 ft. Galvanized Steel Casing Bead	10521	30	1,200
1/2 in. x 10 ft. Vinyl Casing Bead	10516	100	2,500
3/4 in. x 10 ft. Galvanized Steel Casing Bead	10522	30	1,200
3/4 in. x 10 ft. Vinyl Stucco Casing Bead	10517	75	1,875

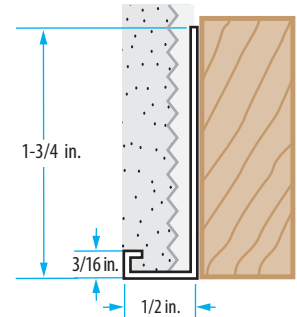

Expanded Outside Corner Bead

Expanded diamond mesh wings allow for keying the plaster right up to the nose of the bead. Provides plumb reinforcement at corners.

Description	Part#	Carton	Pallet
8 ft. Galvanized Steel Outside Expansion Bead	10508	40	800
10 ft. Galvanized Steel Outside Expansion Bead	10507	30	900



Expanded Inside Corner Bead

Finished edge corner lath provide reinforcement for plastered inner corners. Preshaped to 105° for a snug fit in 90° corners with wings tight against the plaster base.

Description	Part#	Carton	Pallet
3 in. x 3 in. x 8 ft. Galvanized Steel Inside Corner Bead	10509	75	1,500

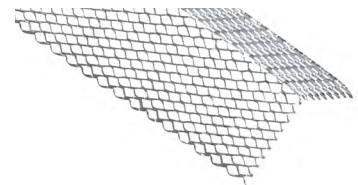

Galvanized Kal-Korner

Galvanized steel to protect exterior corners with veneer plastering. Flanges: 1-1/4 in.

Description	Part#	Carton	Pallet
1-1/4 in. x 1-1/4 in. x 8 ft. Galvanized Steel Corner Bead	99465	80	2,240
1-1/4 in. x 1-1/4 in. x 10 ft. Galvanized Steel Corner Bead	10510	60	1,680



Vinyl Corner Bead

Reinforces exterior corners with durable and straight corners.

Description	Part#	Carton	Pallet
2-1/2 in. x 2-1/2 in. 10 ft. Vinyl Corner Bead	10515	50	1250



Diamond Steel Framing™ Stud

Featuring embossed chevrons to increase strength and provide proper orientation during installation. Stiffening ribs provide additional strength and rigidity. Deep knurling allows for secure screw connections. 25 Gauge Galvanized Steel.

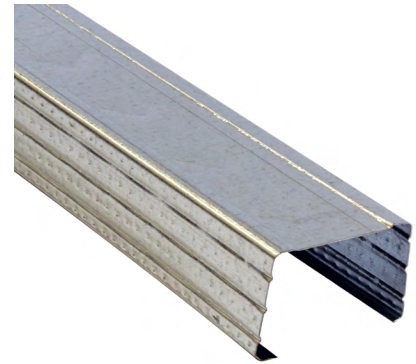

Description	Part#	Bundle	Pallet
1-5/8 in. x 8 ft. Diamond Steel Framing Stud	15964	10	180
1-5/8 in. x 10 ft. Diamond Steel Framing Stud	15962	10	180
2-1/2 in. x 8 ft. Diamond Steel Framing Stud	15968	10	240
2-1/2 in. x 10 ft. Diamond Steel Framing Stud	15966	10	240
3-5/8 in. x 8 ft. Diamond Steel Framing Stud	15978	10	180
3-5/8 in. x 10 ft. Diamond Steel Framing Stud	15970	10	180
3-5/8 in. x 12 ft. Diamond Steel Framing Stud	15972	10	180

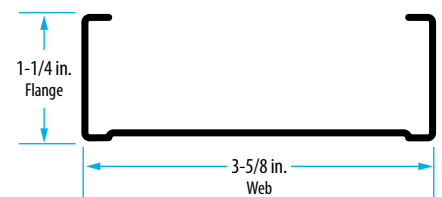
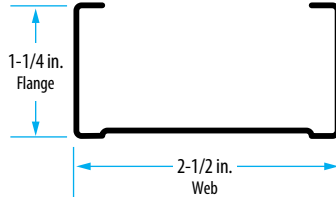
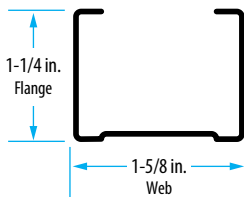

Diamond Steel Framing™ Track

Track is used to anchor the partition at floor and ceiling. Channel configuration formed with unhemmed legs sized to receive the corresponding size stud. 25 Gauge Galvanized Steel.



Description	Part#	Bundle	Pallet
1-5/8 in. x 10 ft. Diamond Steel Framing Track	17036	10	180
2-1/2 in. x 10 ft. Diamond Steel Framing Track	17038	10	240
3-5/8 in. x 10 ft. Diamond Steel Framing Track	17040	10	180

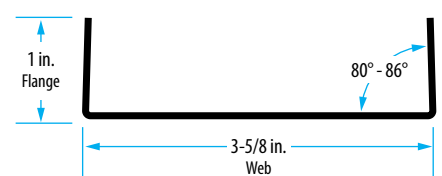
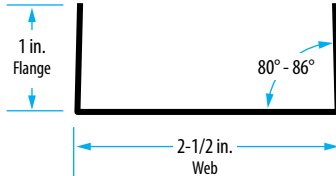
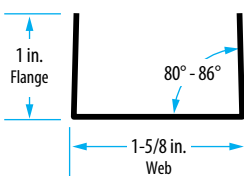

Track flanges are "toed" in to provide a friction grip on the stud.

Furring Channel

also known as Hat Channel, is a corrosion-resistant framing component used to level uneven surfaces prior to applying drywall sheets to walls and ceilings. 25 Gauge Galvanized Steel.

Description	Part#	Bundle	Pallet
7/8 in. x 12 ft. High Hat Furring Channel	13194	10	500

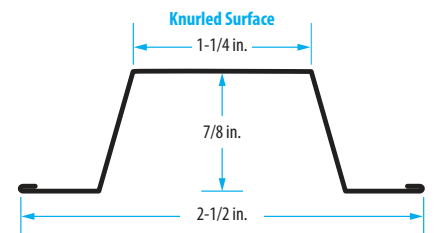

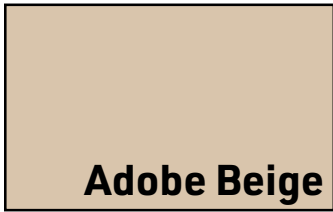
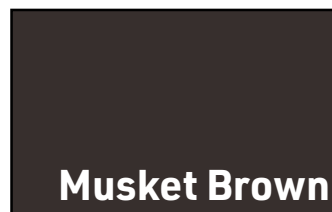
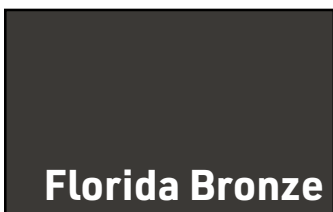
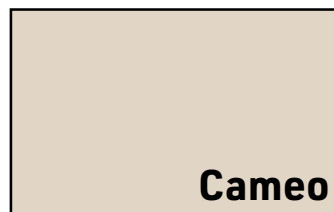
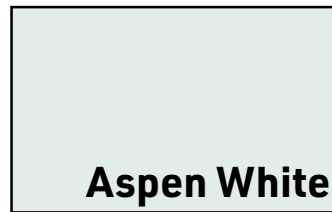
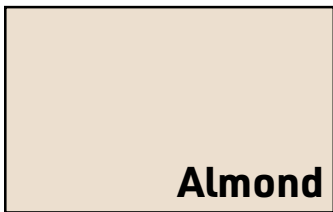
Steel Flashing Colors**Aluminum Flashing Colors**

Aluminum Ventilation Colors

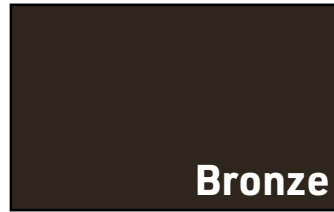

Aluminum Soffit Colors

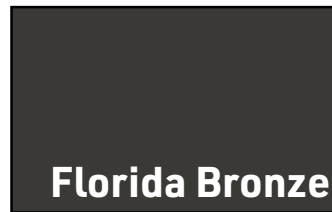
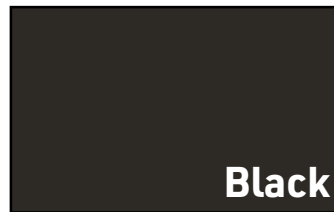
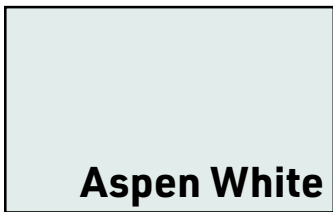

GIBRALTAR

BUILDING ACCESSORIES DIVISION

"Provider of Quality Building Accessories, Built Upon Regional Expertise"

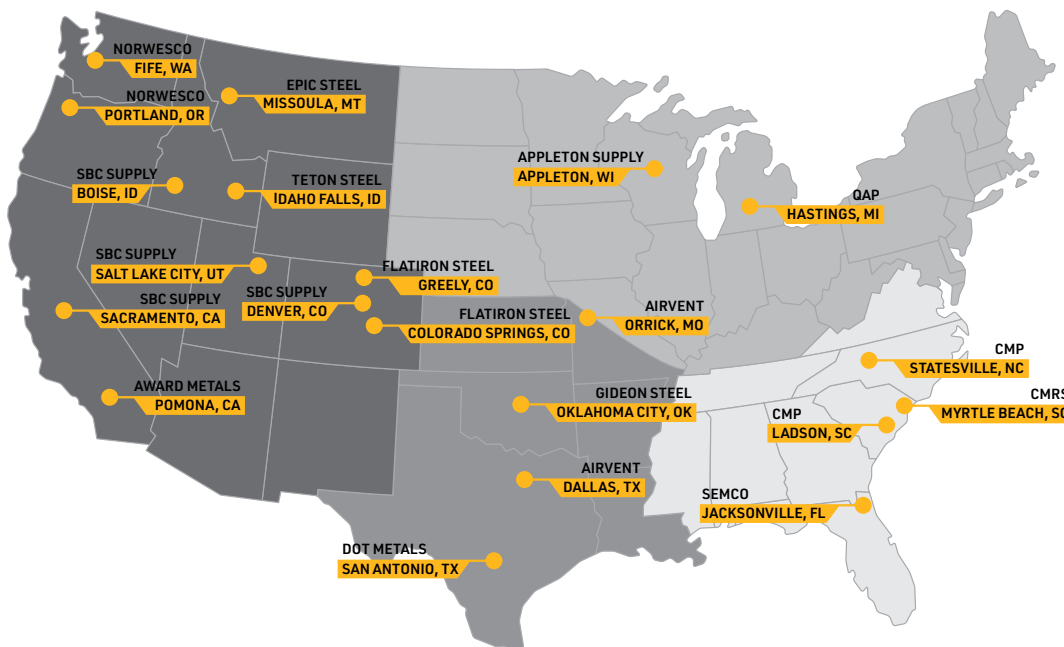

- ✓ **Trims & Flashing**
- ✓ **Metal Roofing**
- ✓ **Ventilation**
- ✓ **Drywall Bead**
- ✓ **Stucco & Plaster**
- ✓ **Soffit & Fascia**
- ✓ **Steel Framing**

