

2026 PRODUCT CATALOG

- ✓ Trims & Flashing
- ✓ Metal Roofing
- ✓ Ventilation
- ✓ Drywall Bead
- ✓ Stucco & Plaster
- ✓ Soffit & Fascia
- ✓ Steel Framing

Professional Grade



DELIVERIES: 7 TO 10 BUSINESS DAYS

TOLL FREE CUSTOMER SERVICE

800-426-0940

AK, ID, MT, OR, UT, WA



NORWESCO

3011 70th Ave. E., Fife, WA 98424-3609

Tel: 800-426-0940 · Fax: 800-343-3063

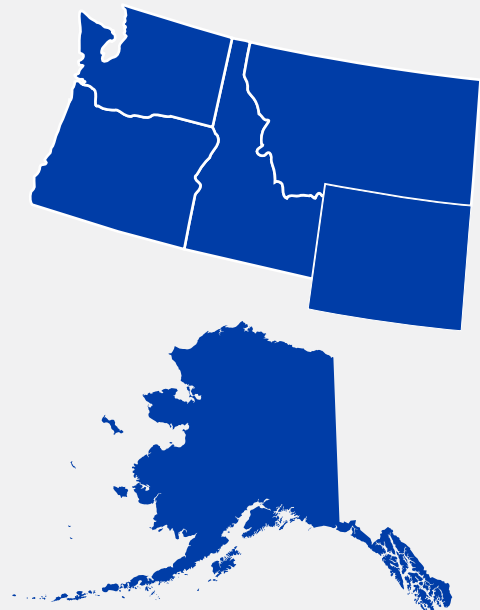

Metal Roofing

Corrugated	3
2 1/2" Corrugated Roofing Panels	3
SM-Rib	3

Metal Roofing Accessories

Ridge Cap Flashing	4
Butyl Tape	4
Woodfast Screws	4
Moss Control Roll	4
Closure Strips	4

Trims & Flashings

Bare Metal Drip Edge	5
Painted Drip Edge	5
Hemmed Roof Edge	6
Fascia Cap	6
Gravel Stop	6
Grip Edge Gravel Stop	7
T-Metal	7
Roof Starter	7
Style-D Eave Drip	7
Tile Pan	7
Painted L-Flashing	8
Painted Roof to Wall	9
W-Valley	9
Zinc W-Valley	9
Z-Flashing	9
Millwork Z-Flashing	10
Stainless Steel Z-Flashing	10
Siding Corners	10

Roll Flashing

Galvanized Steel Roll Flashing	11
Painted Steel Roll Flashing	11
Aluminum Roll Flashing	11
7" Spool Painted Steel Roll Flashing	11

Flat Stock & Step Flashing

Galvanized Flat Shingles	12
Painted Flat Shingles	12

Step Flashing

Painted Step Flashing	13
Galvanized Step Flashing	13
Adjustable Pipe Flashing	14

Pipe Flashing/Gable Louvers/ Rooftop Vents

Multi Size Pipe Flashing	14
Galvanized	14
Plastic	14
Norwesco® Reversible Vent	14
Vent Adapter	14
Aluminum	14
Repair Collar	14
Aluminum Mesh	14

Rooftop Vents

Plastic Stem Vent	15
Plastic Vent	15
Steel Vent	16

Sidewall Vents

Aluminum Louvered Vents	17
Flat Screen Vent	17
Mini Louver	17

Eave & Soffit Vents

Continuous Soffit Vent	18
Soffit Vent	18
Flush Mount Soffit Vent	18
Eave Vent	18

Foundation Vents

Damper Doors · Foundation Vent Clips	19
Foam Plugs	19
Pour-In-Place Foundation Vent	19
Stamped Foundation Vent	19
Rim Vent	19

Foundation Vent Wells

Plastic Vent Wells	20
--------------------------	----

Drywall Corner Bead

Tape-On Outside Corners	21
Tape-On Inside Corners	21
Tape On L-Trim	22
Tape-On Shadow Trim	23
Tape-On Reveal Trim	23
Tape-On J-Trim	23
Nail-On Outside Corner	24

Corrugated

exposed fastener roofing panel. 21-1/2 inch width roofing coverage. 24 inch width siding coverage.
Applications: Residential, Agricultural, Architectural, Light Commercial

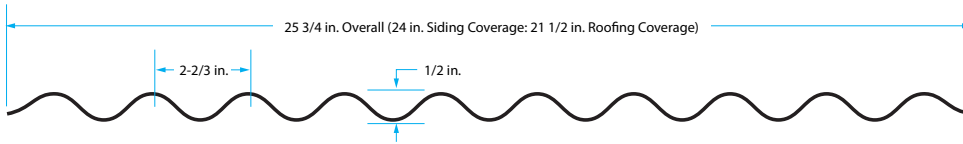

2 1/2" Corrugated Roofing Panels - Pack Quantity: 50

Description	29 Gauge	31 Gauge
6 ft.	CR6G-U	-
8 ft.	CR8G-U	13513
10 ft.	CR10G-U	-
12 ft.	CR12G-U	13506
14 ft.	CR14G-U	-
16 ft.	CR16G-U	-

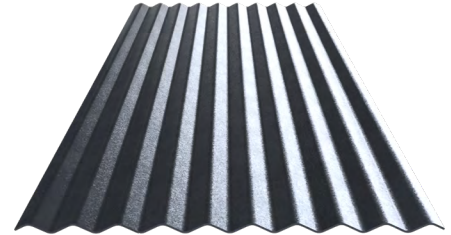

G90, conforming to ASTM A446

Code Approvals

UL Fire Resistant Directory #R20735
UL Listing Directory #R20735
Florida Building #FL-11175



Testing Data & Specifications

Accelerated testing 2000 hours - ASTM G23
Salt Spray testing 1000 hours - ASTM B117
Uplift testing - TAS 125

SM-Rib

exposed fastener siding panel. 36 inch width coverage.
Applications: Residential, Agricultural, Light Commercial, Industrial

Size	Acrylic/Galv/Zinc	White	Red	Gray	Slate	Black	Green
8 ft.	987601	987609	987618	987627	987635	987646	987655
10 ft.	987602	987610	987619	987628	987636	-	-
12 ft.	987603	987611	987620	987629	987637	987648	987657
14 ft.	987604	987612	987621	987630	987638	-	-
16 ft.	987605	987613	987622	987631	987639	-	-

28 Gauge

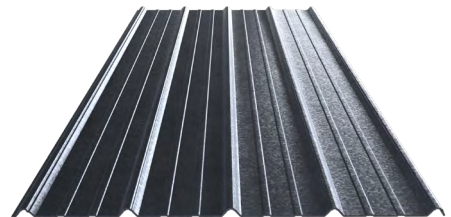

Code Approvals

UL Fire Resistant Directory #R20735



Testing Data & Specifications

Accelerated testing 2000 hours - ASTM G23
Salt Spray testing 1000 hours - ASTM B117
Fire Testing - ASTM E108 or UL 790
Wind Driven Rain - TAS 100
Uplift Testing - TAS 125

1. For the most recent code approval numbers, contact Gibraltar Building Products Technical Department or refer to the appropriate code agency.

Ridge Cap Flashing

for hip and ridge roof sections. For shingle or metal roof applications.
10 ft. lengths · Galvanized Steel · Pack Quantity: 10

Description	Part #
10 in. Corrugated Ridge Cap	CRC10G

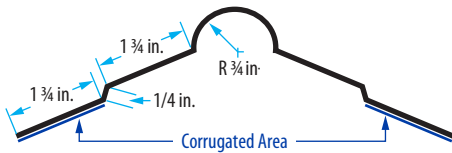

Woodfast Screws

Galvanized #10 Hex-Head with neoprene gasket and self-piercing tip.
100 per bag · 10 bags per carton

Description	Part #
#10 x 1-1/2 in. Woodfast Screw	34166



Closure Strips

Foam closure strips have a self-adhesive backing for ease of installation.
Pack Quantity: 100

Description	Part #
SM-Rib Inside	98190
SM-Rib Outside	98191



Butyl Tape

used to seal metal-to-metal connections. 32 rolls per carton

Description	Part #
50 ft. Butyl Tape	99415



Moss Control Roll

Zinc strip to prevent moss from growing. 6 rolls per carton

Description	Part #
2-1/2 in. x 50 ft. with nails	MB50
2-1/2 in. x 50 ft. without nails	519124



Bare Metal Drip Edge 10 ft. lengths

Galvanized: A x B	30 Ga.	28 Ga.	26 Ga.
1 in. x 2 in.	-	RE12G	-
1-1/2 in. x 1-1/2 in.	-	RE15G	RE15G-26
1-3/8 in. x 1-3/4 in.	516764	-	-
2 in. x 2 in.	-	RE22G	RE22G-26
2 in. x 2-1/4 in.	-	RE90G	-
2 in. x 3/4 in.	516765	-	-
2-1/4 in. x 2 in.	-	REL90G	-

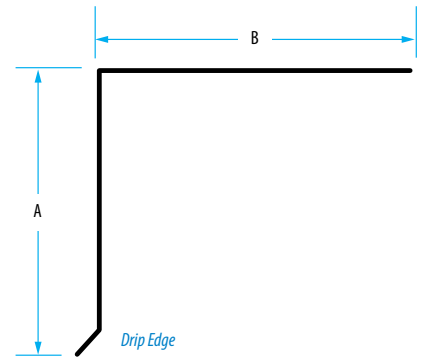

Painted Drip Edge 10 ft. lengths

30 Gauge: A x B	Black	Dark Brown	Gray	White	Brown
1-3/8 in. x 1 in.	-	517978	-	-	-
1-3/8 in. x 1-3/4 in.	516564	516864	516664	516964	-
1-3/8 in. x 1-3/8 in.	-	-	-	517979	-
2 in. x 1-1/2 in.	517602	516346	517603	517600	517601
2 in. x 2 in. x 1/4 in.	-	516876TS	-	-	-
2 in. x 2 in. PNW	517776	516876	517966	516976	-
2 in. x 3/4 in.	-	516865	-	-	-
3 in. x 2 in.	-	-	517781	-	-
3 in. x 3 in.	-	-	-	516982	-

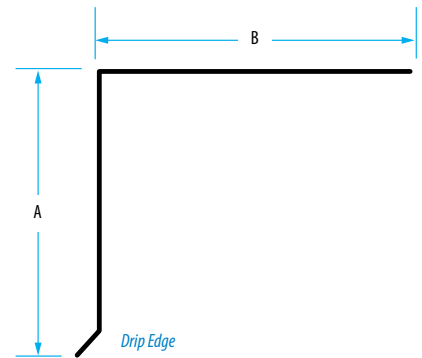

28 Gauge: A x B	Black	Brown	Charcoal	D. Brown	Gray	R. Brown	White
1 in. x 2 in.	-	-	-	-	-	-	RE12WH
1-1/2 in. x 1-1/2 in.	RE15BL	RE15BR	RE15CH	RE15BRW	RE15GR	RE15BRU	RE15WH
1-3/8 in. x 1 in.	516121	-	-	-	-	-	-
1-3/8 in. x 1-3/8 in.	-	-	-	517514	-	-	-
2 in. x 1 1/8 in.	-	-	-	-	-	-	517186
2 in. x 1-1/2 in.	-	-	-	517191	-	-	517185
2 in. x 2 in.	RE22BL	RE22BR	RE22CH	-	-	RE22BRU	RE22WH
2 in. x 3 in.	-	RE23BR	RE23CH	RE23BRW	-	RE23BRU	RE23WH
3 in. x 1-3/8	517959	-	-	-	-	-	-
3 in. x 3 in.	RE33BL	RE33BR	RE33CH	RE33BRW	-	-	517656
4 in. x 1-3/8 in.	-	-	-	517046	-	-	-

26 Gauge: A x B	Black	Brown	D. Brown	Gray	White
1-3/4 in. x 1-3/8 in.	516172	-	516170	516173	516171
2 in. x 2 in. PNW	517969	-	517967	517949	517229
4 in. x 1-3/4 in.	517572	517573	-	-	-
5 in. x 3 in.	517710	-	-	-	-

Hemmed Roof Edge 28 Gauge · 10 ft. lengths · Pack Quantity: 10

RE Style

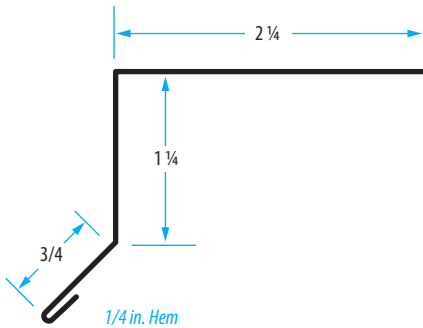

Finish	Part #
Galvanized	RE90G
Black	RE90BL
Clay	RE90CL
Royal Brown	RE90BRU
Tan	RE90TN
White	RE90WH

REL Style

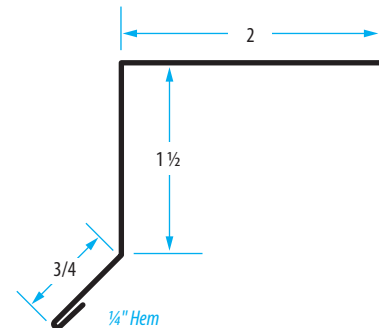

Finish	Part #
Galvanized	REL90G
Black	REL90BL
Royal Brown	REL90BRU
White	REL90WH

Fascia Cap 28 Gauge · 10 ft. lengths · Pack Quantity: 10

Color	Part #
Dark Brown	FC2BRW

Protects roof edges by diverting water away from a wooden fascia board. The lower face has a drip edge; the upper face has a grip edge.

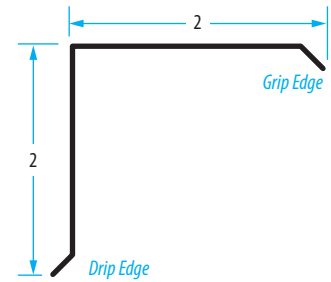

26 Gauge Gravel Stop 10 ft. lengths · Pack Quantity: 10

Size: A x B	Black
2-1/4 in. x 2 in. + 5/8" rise	517870

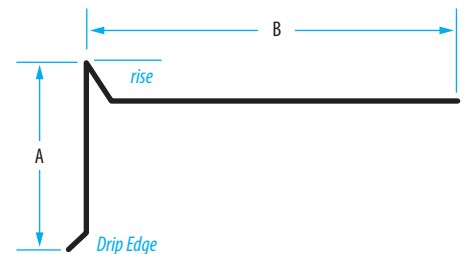

Grip Edge Gravel Stop 28 Gauge - 10 ft. lengths - Pack Quantity: 10

Size: A x B	Galvanized
2 in. x 4 in. + 1/2" rise	GEGS24G

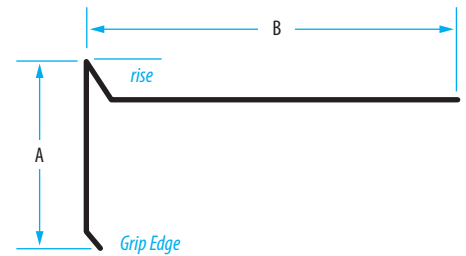

T-Metal 10 ft. lengths - Pack Quantity: 10

	Black	Dark Brown	Gray	White
A - 26 Gauge	TMETBL-26	TMETBRW-26	516228	516226
B - 26 Gauge	517203	517201	-	517204

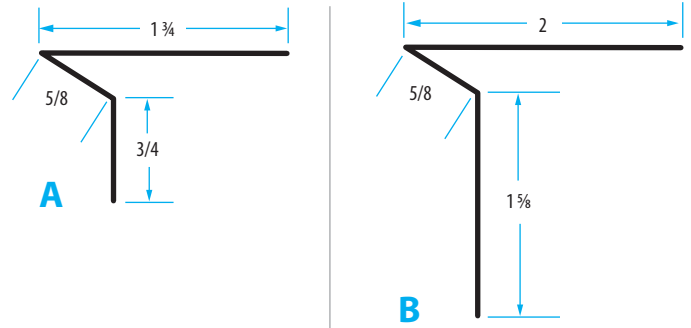

Roof Starter #230 10 ft. lengths - Pack Quantity: 10

Gauge	Galvanized	Stainless	Black	Dk. Brown	White
28	RSG	RSSS	516670	516860	-
26	-	-	517132	517130	517131

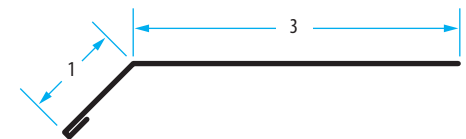

Style-D Eave Drip 10 ft. lengths - Pack: 25

28 Gauge - No Hem	
Galvanized	SDG
Black	SDBL
Dark Brown	SDBRW
Gray	SDGR
Royal Brown	SDBRU
White	SDWH

26 Gauge - Hemmed	
Black	517970
Dark Brown	517980
White	517990

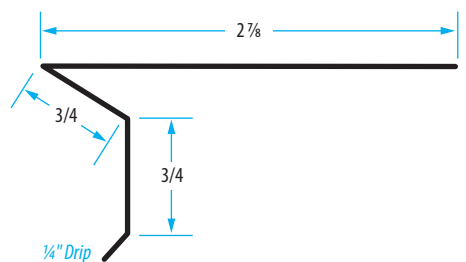

30 Gauge - Hemmed	
Galvanized	516763
Black	516663
Dark Brown	516863
Gray	517963
White	516963

Tile Pan

26 Gauge Zinc
10 ft. lengths - Pack Quantity: 10

Size: A x B x C	Zinc
3-1/2 in. x 8 in x 1/2 in	TP12Z-26



Saddle Stock Galvanized Steel · 10 ft. lengths

Size: A x B	Black	Dark Brown	Gray	QTY
5 in. x 13 in. - 28 Ga.	517772	518772	-	5
5 in. x 13 in. - 26 Ga.	517786	517784	517787	5

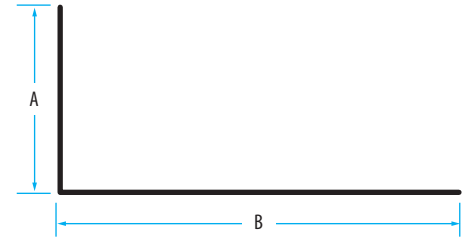

Bare Metal L-Flashing Galvanized Steel · 10 ft. lengths

Size: A x B	Galvanized			Bonderized
	30 Ga.	28 Ga.	26 Ga.	26 Ga.
1 in. x 1 in.	516707	-	-	-
1 in. x 1-1/2 in.	516702	LF115G	-	-
1-1/2 in. x 1-1/2 in.	516704	LF15G	-	-
1 in. x 2 in.	516703	LF12G	-	-
2 in. x 2 in.	-	-	LF22G-26	-
2 in. x 4 in.	-	516746	LF24G-26	LF24B-26
4 in. x 6 in.	516695	LF46G	LF46G-26	LF46B-26

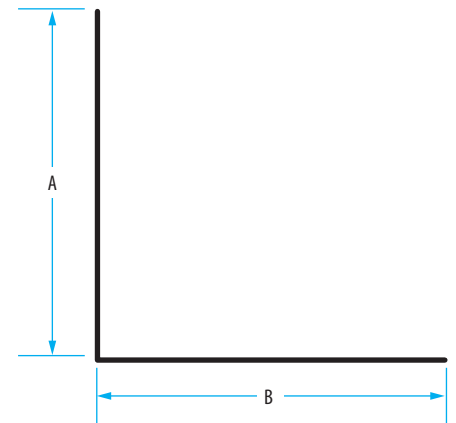

Painted L-Flashing Galvanized Steel · 10 ft. lengths

Size: A x B	Black	Dark Brown		White	
	28 Ga.	30 Ga.	28 Ga.	30 Ga.	28 Ga.
1.5 in. x 1.5 in.	-	516804	LF15BRW	516904	-
4 in. x 4 in.	516608	-	516808	-	516908
6 in. x 6 in.	LF66BL	-	516809	-	-

Size: A x B	Gray	Black
4 in. x 4 in.	516508	517221

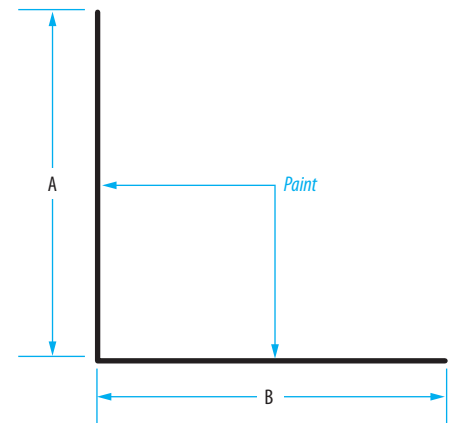

30 Gauge Painted Roof to Wall 10 ft. lengths · Pack Quantity: 20

Size: A x B	Black	Dark Brown	Gray
1 in. x 3 in.	516655	516847	517947

28 Gauge Painted Roof to Wall 10 ft. lengths · Pack Quantity: 20

Size: A x B	Black	Dark Brown	White
3 in. x 5 in.	RW35BL	RW35BRW	516956
4 in. x 4 in.	516610	516810	516910
4 in. x 6 in.	-	516511	-
6 in. x 6 in.	-	516812	-

26 Gauge Painted Roof to Wall 10 ft. lengths · Pack Quantity: 20

Size: A x B	Black	Dark Brown	Gray	White
1 in. x 3 in.	516215	516213	516216	516214
2 in. x 3 in.	516219	516217	-	-
3 in. x 5 in.	516223	516221	517956	-

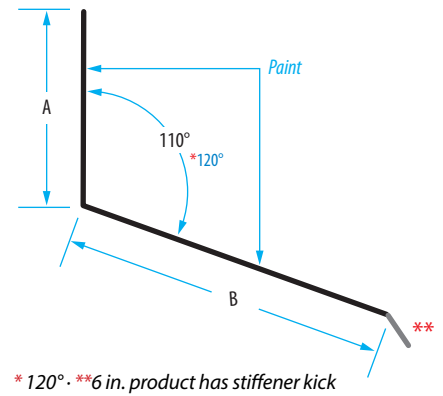

28 Gauge W-Valley 10 ft. lengths · Pack Quantity: 10

Description	Galv.	Bronze	Black	Brown	Dark Brown
18 in. - Hemmed	V18G	-	-	V18BR	-
24 in. - Hemmed	V24G	V24BRZ	V24BL	V24BR	V24BRW

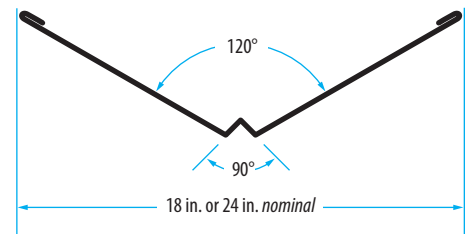

26 Gauge W-Valley 10 ft. lengths · Pack Quantity: 10

Description	Galv.	White	Black	Brown	D.Brown	Gray
18 in. - No Hem	V18G-26	V18WH-26	-	V18BR-26	516237	-
24 in. - Hemmed	V24G-26	-	516247	-	516253	516257

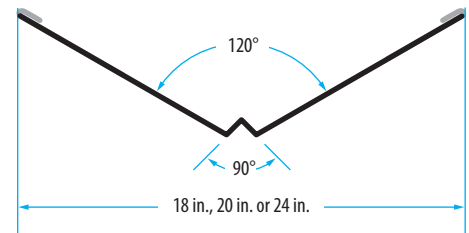

26 Gauge Zinc W-Valley 10 ft. lengths · Pack Quantity: 10

Description	Galv.
24 in. Open Hem Galv	V24GOH-26
24 in. 3 Rib, Hemmed	V24Z3R-26

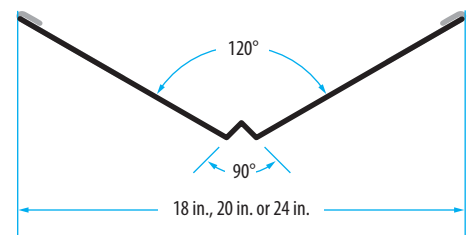

30 Gauge Z-Flashing 10 ft. lengths · 30 Gauge Galvanized Steel · Pack Quantity: 20

Size: A x B x C	Galvanized	Dark Brown	White
1/4 in. x 1-1/4 in. x 1 in.	-	-	516966
1/4 in. x 1-1/2 in. x 1 in.	516786	516886	516986
1/4 in. x 1-5/8 in. x 1 in.	-	516896	-
3/8 in. x 1 in. x 3/4 in.	870125	-	516927
3/8 in. x 2 in. x 3/4 in.	-	516836	-

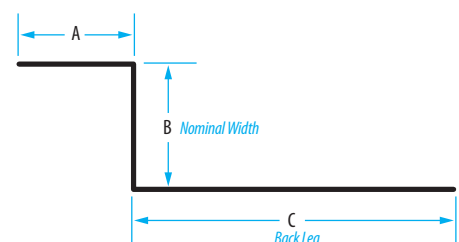

28 Gauge Z-Flashing 10 ft. lengths - 28 Gauge Galvanized Steel

Size: A x B x C	Galvanized	Bonderized	Brown	Dark Brown	White
3/8 in. x 5/16 in. x 2-5/16 in. - 8 ft.	SZB516G-8	-	-	-	-
3/8 in. x 7/16 in. x 2-3/16 in.	SZB716G	-	-	-	-
3/8 in. x 7/16 in. x 2-1/4 in.	SZB716G	-	-	-	-
3/8 in. x 5/8 in. x 2 in.	SZB58G	SZB58B	SZB58BR	SZB58BRW	SZB58WH
3/8 in. x 5/16 in. x 2-1/4 in.	516724	-	-	-	-
3/8 in. x 3/8 in. x 2 in.	SZB38G	-	SZB38BR	516821	SZB38WH
3/8 in. x 3/4 in. x 1-7/8 in. - 8 ft.	SZB34GAL-8	-	-	-	-
3/8 in. x 3/4 in. x 1-7/8 in.	SZB34G	-	-	516859	516959
3/8 in. x 1-1/8 in. x 2 in.	SZB118G-2	-	-	-	-
3/8 in. x 1-1/4 in. x 2 in.	SZB125G-2	-	-	-	-
3/8 in. x 1-1/2 in. x 2 in.	SZB115G-2	-	-	-	-
3/8 in. x 1/2 in. x 2-1/8 in.	SZB12G	-	-	SZB12BRW	516958
3/8 in. x 1 in. x 2 in.	SZB1G-2	-	-	-	-
3/8 in. x 1 in. x 1-5/8 in.	-	-	-	-	517267

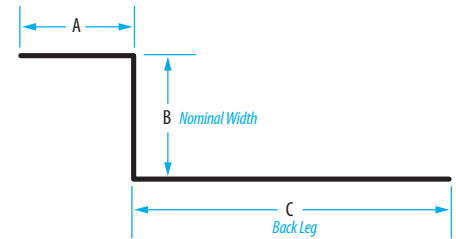

All bends 90° except those marked with * 100° B leg

Millwork Z-Flashing 10 ft. lengths - 28 Gauge Galvanized Steel - Pack Quantity: 10

Size: A x B x C	Galvanized	Bonderized	White
1/4 in. x 1-1/4 in. x 1-3/8 in.	FLGAWF	-	-
3/8 in. x 1-1/2 in. x 2 in.	SZB115G-2	-	-
3/8 in. x 1-1/4 in. x 2 in.	SZB125G-2	-	-
3/8 in. x 1-1/8 in. x 2 in.	SZB118G-2	-	SZB118WH-2

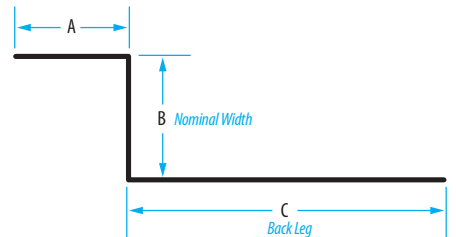

Stainless Steel Z-Flashing 10 ft. lengths - 28 Gauge Galvanized Steel - Pack Quantity: 10

Size: A x B x C	Stainless Steel
3/8 in. x 5/8 in. x 2 in.	SZB58SS
3/8 in. x 3/4 in. x 1-7/8 in.	SZB34SS
3/8 in. x 1 in. x 2 in.	SZB1SS-2
3/8 in. x 1-1/2 in. x 2 in.	SZB115SS-2

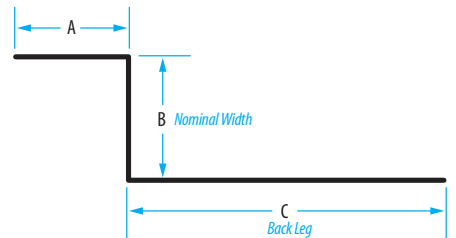

Siding Corners Pack Quantity: 200

Size	Part #
1/2 in. x 8 in. - 26 Ga. Bonderized Steel	SC128
3/4 in. x 8 in. - 26 Ga. Bonderized Steel	513010
3/4 in. x 12 in. - 26 Ga. Bonderized Steel	SC3412



Galvanized Steel Roll Flashing

Size	30 Gauge			28 Gauge		26 Gauge
	10 ft.	25 ft.	50 ft.	25 ft.	50 ft.	50 ft.
7 in.	518940	518945	518906	RV725G	-	-
8 in.	-	-	518907	-	-	RV850G-26
10 in.	518941/ RV1010G	518946/ RV1025G	518908/ RV1050G-30	-	-	-
12 in.	-	-	-	RV1225G	-	-
14 in.	518942	518947	518902	RV1425G	RV1450G	-
16 in.	-	-	518917	-	-	-
20 in.	518943	518948	518904	RV2025G	RV2050G-28	RV2050G-26
24 in.	-	-	518919	-	-	-



Painted Steel Roll Flashing

Size	Dark Brown 30 Gauge			Black/Gray 30 Ga.	Black/D. Brown 26 Ga.
	10 ft.	25 ft.	50 ft.	50 ft.	50 ft.
7 in.	518980	518985	518932	-	-
8 in.	-	-	-	-	519020
10 in.	518981	518986	518933	-	-
14 in.	518982	518987	518930	518991	519027
16 in.	-	-	518929	-	-
20 in.	518983	518988	-	-	519028
24 in.	-	-	518960	-	-



Aluminum Roll Flashing

Size	10 ft.	25 ft.	50 ft.
6 in.	-	RV625A	-
7 in.	RV710A	518955	RV750A
10 in.	RV1010A	RV1025A	RV1050A
14 in.	RV1410A	RV1425A	RV1450A
20 in.	RV2010A	RV2025A	RV2050A



7" Spool Painted Steel Roll Flashing

7 inch diameter spool • 28 Gauge • Pack Quantity:1

Size	Part #
20 in. x 50 ft. - Black/Gray	RV2050BLGR

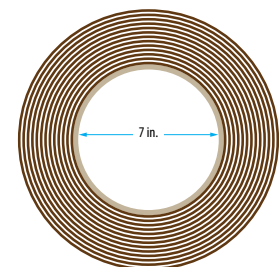

Galvanized Flat Shingles

Size	Part #	QTY
5 in. x 7 in. 30 Ga. Galvanized Steel	511001	100
5 in. x 8 in. 30 Ga. Galvanized Steel	511002	100
8 in. x 12 in. 30 Ga. Galvanized Steel	511011	50
5 in. x 7 in. 28 Ga. Galvanized Steel - each	S57EA-200	200
5 in. x 8 in. 28 Ga. Galvanized Steel - each	S58EA-200	200
8 in. x 12 in. 28 Ga. Galvanized Steel - each	S812EA-100	100

Painted Flat Shingles

Black/Dark Brown • 26 Ga.

26	Part #	QTY
5 in. x 8 in.	511127	100
8 in. x 8 in.	511129	50
8 in. x 10 in.	511134	50
8 in. x 12 in.	511136	50

Gray • 30 Gauge

30	Part #	QTY
8 in. x 8 in.	511093	100

Black/Gray • 28 & 30 Gauge

30	Part #	QTY
5 in. x 8 in.	511024	100
8 in. x 8 in.	511069	50
8 in. x 12 in.	511018	50
8 in. x 14 in.	511045	50

28	Part #	QTY
5 in. x 8 in.	S58BLGREA-200	200
8 in. x 12 in.	S812BLGREA-100	100

Dark Brown • 28 & 30 Gauge

30	Part #	QTY
5 in. x 8 in.	511003	100
8 in. x 8 in.	511019	50
8 in. x 12 in.	511004	50
8 in. x 14 in.	511005	50

28	Part #	QTY
5 in. x 8 in.	S58BRWEA-200	200
8 in. x 12 in.	S812BRWEA-100	100

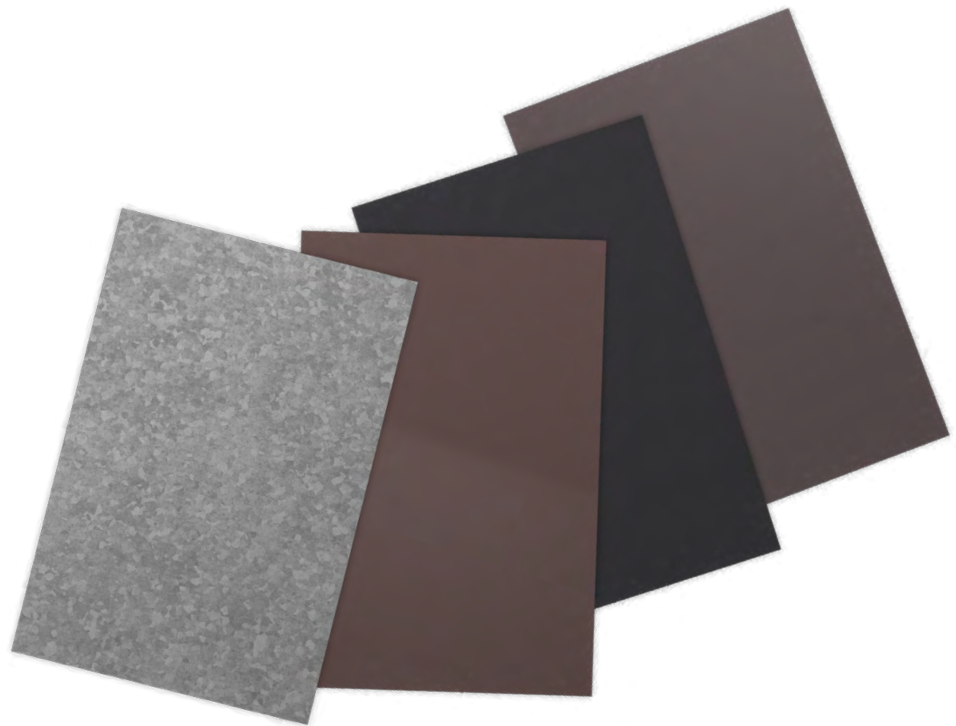

30 Gauge Galvanized Step Flashing

Description	Part #	QTY
4 in. x 4 in. x 8 in. - 30 Gauge	511015	50
4 in. x 4 in. x 12 in. - 30 Gauge	511013	50
4 in. x 4 in. x 14 in. - 30 Gauge	518004	50



28 Gauge Galvanized Step Flashing

Description	Part #	QTY
3 in. x 3 in. x 7 in. - 28 Gauge - 25 pack	SF337G-25	25
3 in. x 4 in. x 7 in. - 28 Gauge - each	SF347EA-200	200
3 in. x 5 in. x 8 in. - 28 Gauge. - 25 pack	SF358G-25	25
4 in. x 4 in. x 8 in. - 28 Gauge - each	SF448EA-50	50
4 in. x 4 in. x 12 in. - 28 Gauge - each	SF4412EA-100	100

Step Flashing with the word "each" in the description are individually bar coded.

Painted Step Flashing

Black - 26, 28 & 30 Gauge

30 Gauge	Part #	QTY
4 x 4 x 12 in.	511037	50
4 x 4 x 14 in.	518044	50

28 Gauge	Part #	QTY
4 x 4 x 8 in.	511040	50
4 x 4 x 12 in. - each	SF4412BLEA-100	100

Dark Brown - 26, 28 & 30 Gauge

28 Gauge	Part #	QTY
4 x 4 x 8 in.	511020	50
4 x 4 x 12 in. - each	SF4412BRWEA-100	100
4 x 6 x 14 in. - 25 pk	SF4614BRW-25	10

30 Gauge	Part #	QTY
4 x 4 x 12 in.	511008	50
4 x 6 x 14 in.	518014	50

26 Gauge	Part #	QTY
4 x 4 x 8 in.	511061	50

Gray - 30 Gauge

30 Gauge	Part #	QTY
4 x 4 x 8 in.	511050	50
4 x 4 x 12 in.	511038	25
4 x 4 x 14 in.	518054	50

White - 30 Gauge

30 Gauge	Part #	QTY
4 x 4 x 8 in.	511060	50
4 x 4 x 12 in.	511036	50
4 x 4 x 14 in.	518034	50



Black

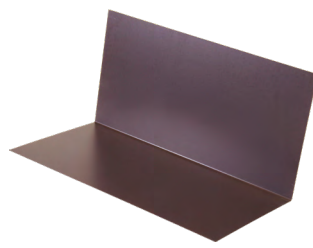

Dark Brown

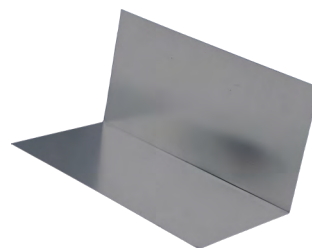

Gray

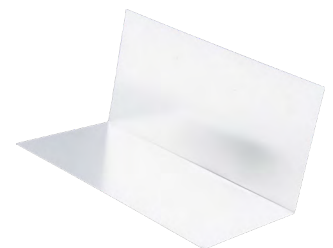

White

Multi Size Pipe Flashing

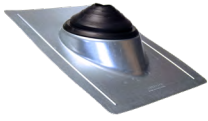

Galvanized Multi Size 1-1/4" - 4"

Part #	Color	QTY
56001	Mill Finish	12
56009	Black	12
56010	Brown	12
56011	Weatherwood	12

Aluminum Multi Size 1-1/4" - 4"

Part #	Color	QTY
56002	Mill Finish	12
56020	Black	12
56021	Brown	12
56022	Weatherwood	12



Part #	QTY
56003	12



Part #	QTY
56000	20

Plastic Multi Size 1-1/4" - 4"

Repair Collar Multi Size 1-1/4" - 4"



Norwesco® Reversible Vent 30 Ga. Galvanized Steel · Reversible design for more flexible installation.

Size: A x B	N.F.V.	Mill	White	QTY
12 in. x 18 in.	100 sq. in.	-	553830	6
14 in. x 24 in.	162 sq. in.	-	553850	6



Vent Adapter For 6 in. circular roof vent

4 inch	6 inch	7 inch	QTY
559174	559176	559177	6



Kwik Mesh™

Galvanized - 1/8 in. mesh

Size	Part #	QTY.
4 in. x 25 ft.	KM425	6 rolls
6 in. x 25 ft.	KM625	6 rolls
8 in. x 25 ft.	KM825	3 rolls
12 in. x 20 ft.	KM1220	3 rolls

KM425	34.08 sq. in./ft. N.F.A.
KM625	51.12 sq. in./ft. N.F.A.
KM825	68.16 sq. in./ft. N.F.A.
KM1220	102.24 sq. in./ft. N.F.A.



Aluminum Mesh

Aluminum - 1/8 in. mesh

Size	Part #	QTY.
4 in. x 100 ft.	969181	6 rolls
6 in. x 100 ft.	969182	4 rolls
8 in. x 100 ft.	969183	3 rolls
12 in. x 100 ft.	969186	2 rolls

Metal Stem Vent Pack Quantity: 1

Size	Galv. - Stem Only	Black	Dark Brown	Gray
4 inch	556071	556060	556061	556074
6 inch	556072	556064	556065	-
8 inch	-	556070	556069	-



Plastic Stem Vent Pack Quantity: 4

Size	Black	Dark Brown	Gray	White	QTY
4 inch	559427	559428	559425	559429	4
5 inch	559433	559434	-	-	4
6 inch	559439	559440	559437	-	4

4 inch Plastic Roof Cap - No Stem - Black	559415	6
4 inch Plastic Roof Cap - No Stem - Dark Brown	559416	6



50 Square Inch Plastic Vent Pack Quantity: 12

	Black	Brown	Dark Brown	Gray	Weathered Gray
PRV-50	559012	559010	559011	559013	559015
AF-50	559453	559450	559454	559451	559452



PRV-50

AF-50

92 Square Inch Plastic Vent

Black	Brown	Dk. Brown	Gray	Translucent	Weathered Gray	QTY
559471	559468	559472	559469	559445	559470	8



* Translucent Vent has a Gray Base

61 Square Inch Plastic Vent

Color	Part #	QTY
Black	90121	6



RV38 Static Vent - 38 Square Inch Steel Vent Slant Back · Galvanized Steel · 17 in. x 20 in. flange

Galvanized	Black	Gray	White	Dark Brown	QTY
558011	557167	557157	556167	556157	6

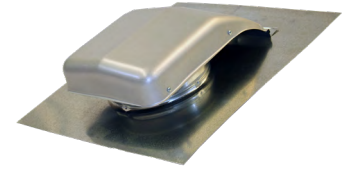

RVO38 Static Vent - 38 Square Inch NFA Steel Vent Square Top · Galvanized Steel · 17 in. x 17 in. flange

	Galvanized	Black	Dark Brown	Gray	White	QTY
Standard	556042	557059	556159	557159	556150	6



Standard RVO38

RV49 Static Vent - 49 Square Inch Steel Vent Slant Back · 18 in. x 22 in. flange

Galvanized	Black	Dk. Brown	Gray	White	QTY
558012	557153	556154	557154	557145	6

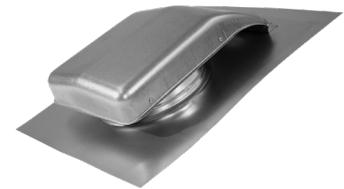

RVO49 Static Vent - 49 Square Inch NFA Steel Vent Square Top · 18 in. x 18 in. flange

Black	Dark Brown	Gray	QTY
557160	556158	557158	6



RVG51 Static Vent - 50 Square Inch NFA Steel Vent

Description	Galvanized	Black	Brown	QTY
Square Top	RVG51000	RVG51010	RVG51080	9



Aluminum Louvered Vents For soffit and eave venting

Size: A x B	N.F.V.	R. Opening	Mill	Brown	White	QTY.
16 in. x 4 in.	28 sq. in.	15 in. x 3 in.	84126	84228	84226	24
16 in. x 6 in.	42 sq. in.	15 in. x 5 in.	84115	84217	84215	24
16 in. x 8 in.	56 sq. in.	15 in. x 7 in.	84210	84212	84211	24



Flat Screen Vent Galvanized Steel · 1/8 in. mesh

Size: A x B	N.F.V.	Rough Opening	Part #	QTY.
16 in. x 8 in.	61.5 sq. in.	14.5 in. x 6.5 in.	SCV168-1/8	25

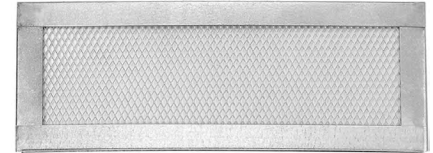

Mini Louver Aluminum, with Screen

Size	N.F.V.	Part #	QTY.
2 inch	0.45 sq. in.	559111	36
2-1/2 inch	1.2 sq. in.	559112	36
3 inch	1.7 sq. in.	559001	36
4 inch	3.5 sq. in.	559002	36



Mini Louver Aluminum, no Screen

Size	N.F.V.	Part #	QTY.
2 inch	0.47 sq. in.	ML2	100
3 inch	1.34 sq. in.	ML3	50
4 inch	2.88 sq. in.	ML4	20



Continuous Soffit Vent

Description	N.F.V.	Mill	Black	Brown	White	QTY.
Aluminum	9 sq. in./ft.	556004	556014	556018	556019	30
Plastic	8.2 sq. in./ft.	-	-	559006	559007	75

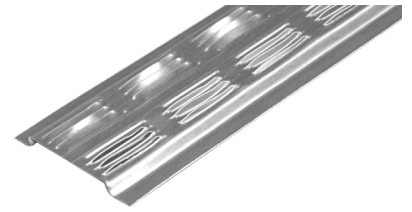

Soffit Vent Stucco Ready · 1/8 inch mesh

Size: A x B	N.F.V.	Rough Opening	Part #	QTY.
14 in. x 5 in.	52.1 sq. in.	14.5 in. x 5.5 in.	SV145-1/8	26
22 in. x 3 in.	51.4 sq. in.	22.5 in. x 3.25 in.	SV223-1/8	9

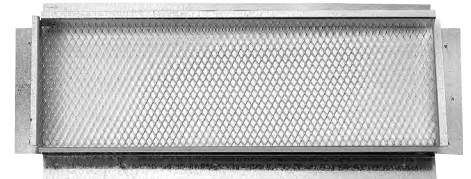

Flush Mount Soffit Vent 1/8 inch Mesh · Pack Quantity: 12

Description	N.F.V.	Galvanized	Brown	White	QTY.
16 in. x 6 in.	40 sq. in.	558006	556147	556447	12
16 in. x 8 in.	58 sq. in.	558007	556148	556448	12

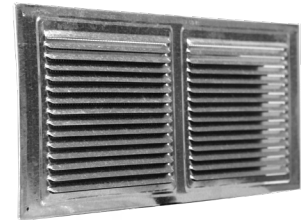

Flush Mount Soffit Vent With Damper · 1/8 inch Mesh · Pack Quantity: 12

Description	N.F.V.	Galvanized	Brown	White	QTY.
16 in. x 4 in.	24 sq. in.	558025			12
16 in. x 8 in.	58 sq. in.	558027	556163	556463	12



with manual damper

Eave Vent Stucco or Straight Flange · 1/8 inch mesh

Size	N.F.V.	Galvanized	Bonderized	Brown	QTY.
22 in. x 3 in. - 1/8 mesh - STU	34.3 sq. in.	EV223-1/8	-	25	25
22 in. x 3 in. - 1/8 mesh - REG	34.3 sq. in.	-	556017	50	50
22 in. x 3 in. w/Louvers - REG	34.3 sq. in.	-	556007	50	50



STU = Stucco Flange
REG = Straight Flange

Damper Doors - Foundation Vent Clips



Description	Part#	QTY.
Vent-Aire Door	559217	80
Norwesco - PFV6-8	596140	72

Stamped Foundation Vent *Stucco Reveal*

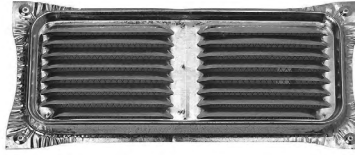

Galvanized

Description	N.F.V.	Part #	QTY.
14x6 in. - 1/8 mesh	51	FV146G-1/8	25

Bonderized

14x6 in. - 1/4 mesh	51	FV146B-1/8	25
---------------------	----	------------	----

Rim Vent Pack Quantity: 24



Rugged UV resistant plastic

Description	N.F.V.	Part #	QTY
16 in. x 8 in. - White	62 sq. in.	559408	8

Foam Plugs Sold in Pairs

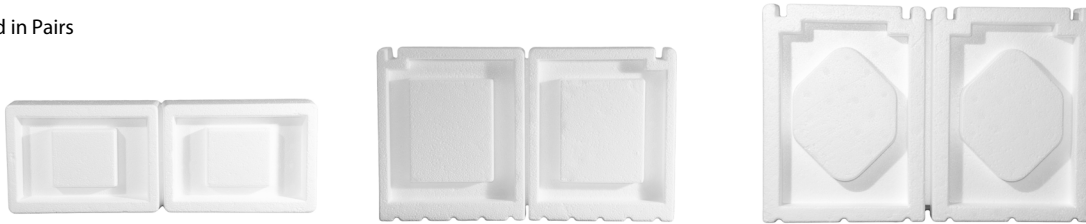

DVBPSM-EA

DVBP

DVBPXL

Description	Part#	QTY.
Lawrence - 5.5 in. x 7.5 in	DVBPSM-EA	45
Vent-Aire - 6.5 in. x 7.75 in.	DVBP	40
Norwesco - 6.5 in. x 8.75 in.	DVBPXL	36

Pour-In-Place Foundation Vent

Description	N.F.V.	Color	Part#	QTY.
PFV-6-8 Combo	100 sq. in.	Gray	596037	12
PFV-6-8 Combo - with damper door	100 sq. in.	Gray	596137	12
6 in. - no door	72.5 sq. in.	Gray	559021	20
6 in. - with damper door	72.5 sq. in.	Gray	559023	20
6 in. - no door	72.5 sq. in.	Black	559020	20
6 in. - with damper door	72.5 sq. in.	Black	559022	20
8 in. - no door	72.5 sq. in.	Gray	559027	15
8 in. - no door	72.5 sq. in.	Black	559026	15
8 in. - with damper door	72.5 sq. in.	Black	559028	15
10 in. - with damper door	72.5 sq. in.	Gray	559035	12

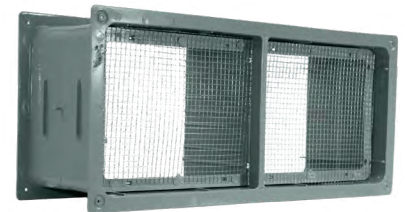

Plastic Vent Wells

Description - A x B x C	Part#	QTY
Dark Brown - 19 in. x 4 in. x 12	569040	10
Gray - 19 in. x 4 in. x 12	569041	10
Gray - 19 in. x 8 in. x 12	569081	6



Drywall items only sold out of Fife, WA · 800-426-0940

90° Tape-On Odd Leg Outside Corner

8 ft. Carton	10 ft. Carton	MLF	Pieces/Carton	Cartons/Pallet
A1W-8	A1W-10	83.5 lbs.	50	60

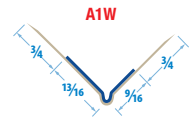
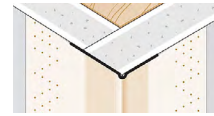

90° Tape-On Extra Wide Odd Leg Outside Corner

9 ft.	10 ft.	12 ft.	MLF	Pcs/Ctn	Ctns/Pal
A1XW-9	A1XW-10	A1XW-12	-	-	-

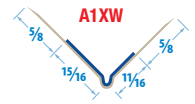

90° Tape-On Extra Wide Even Leg Outside Corner

8 ft.	9 ft.	10 ft.	12 ft.	MLF	Pcs/Ctn	Ctns/Pal
A1XWEL-8	A1XWEL-9	A1XWEL-10	A1XWEL-12	95 lbs.	50	60

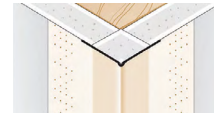

90° Tape-On Extra Wide Even Leg Outside Corner - Sunline™

7 ft.	8 ft.	9 ft.	10 ft.	12 ft.	MLF	Pcs/Ctn	Ctns/Pal
S1XW-7	S1XW-8	S1XW-9	S1XW-10	S1XW-12	103.34 lbs.	50	54

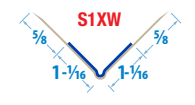

90° Tape-On Extra Extra Wide Even Leg Outside Corner - Sunline™

8 ft.	9 ft.	10 ft.	12 ft.	MLF	Pcs/Ctn	Ctns/Pal
S1XXW-8	S1XXW-9	S1XXW-10	S1XXW-12	121.7 lbs.	50	54

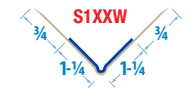

Taper's Bead™ 90° Tape-On Even Leg Outside Corner

8 ft.	9 ft.	10 ft.	MLF	Pcs/Ctn	Ctns/Pal
T1WEL-8	T1WEL-9	T1WEL-10	83.5 lbs.	50	60



Only available in Canada.

Taper's Bead™ 90° Tape-On Extra Wide Even Leg Outside Corner

7 ft.	8 ft.	9 ft.	10 ft.	12 ft.	MLF	Pcs/Ctn	Ctns/Pal
T1XWEL-7	T1XWEL-8	T1XWEL-9	T1XWEL-10	T1XWEL-12	95.5 lbs.	50	60

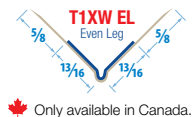

Only available in Canada.

Taper's Choice™ 90° Tape-On Extra Wide Outside Corner

6 ft.	7 ft.	8 ft.	9 ft.	10 ft.	12 ft.	MLF	Ctn	Pal
TC1XW-6	TC1XW-7	TC1XW-8	TC1XW-9	TC1XW-10	TC1XW-12	103.34 lbs.	50	54



Only available in Canada.

Taper's Choice™ 90° Tape-On Extra Extra Wide Outside Corner

7 ft.	8 ft.	9 ft.	10 ft.	12 ft.	MLF	Pcs/Ctn	Ctns/Pal
TC1XXW-7	TC1XXW-8	TC1XXW-9	TC1XXW-10	TC1XXW-12	119.75 lbs.	50	54

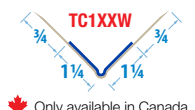

Only available in Canada.

135° Tape-On Open Angle Outside Corner

8 ft. Carton	9 ft. Carton	10 ft. Carton	MLF	Pcs/Ctn	Ctns/Pal
A10A-8	A10A-9	A10A-10	73.5 lbs.	50	60

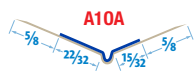
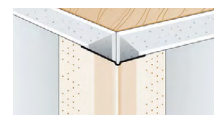

135° Tape-On Open Angle Inside Corner

8 ft. Carton	9 ft. Carton	10 ft. Carton	MLF	Pcs/Ctn	Ctns/Pal
A20A-8	A20A-9	A10A-10	73.5 lbs.	50	60

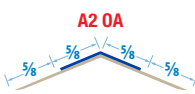

90° Tape-On L-Trim Outside Corner



Tape-On L-Trim is used as a trim piece for wallboard that abuts to suspended ceilings, plaster beams, masonry and concrete surfaces, as well as untrimmed window and door jambs.

50 Pieces per Carton
60 Cartons per Pallet

1/4 inch

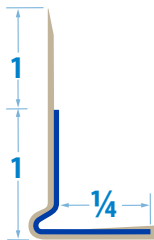

10 ft. Ctn.....**A4-1/4-10**
LBS/MLF.....**73.5**

1/2 inch

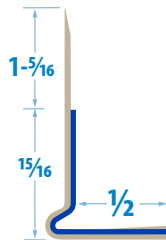

7 ft. Ctn.....**A4-1/2-7**
8 ft. Ctn.....**A4-1/2-8**
10 ft. Ctn.....**A4-1/2-10**
LBS/MLF.....**83.5**

1/2 inch No Bead

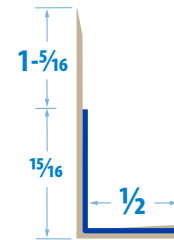

8 ft. Ctn..... **A4-1/2NB-8**
10 ft. Ctn..... **A4-1/2NB-10**
12 ft. Ctn..... **A4-1/2NB-12**
LBS/MLF..... **83.5**

5/8 inch

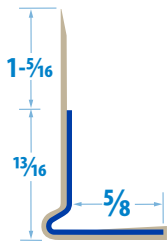

7 ft. Ctn.....**A4-5/8-7**
8 ft. Ctn.....**A4-5/8-8**
10 ft. Ctn.....**A4-5/8-10**
LBS/MLF.....**83.5**

5/8 inch No Bead

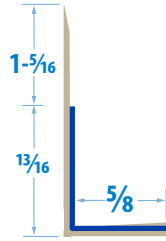

8 ft. Ctn.....**A4-5/8NB-8**
10 ft. Ctn.....**A4-5/8NB-10**
LBS/MLF.....**83.5**

3/4 inch

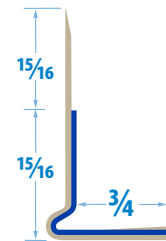

8 ft. Ctn.....**A4-3/4-8**
10 ft. Ctn.....**A4-3/4-10**
LBS/MLF.....**95.0**

1 inch

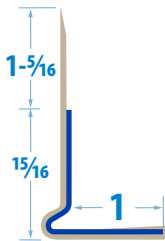

8 ft. Ctn.....**A4-1-8**
10 ft. Ctn.....**A4-1-10**
LBS/MLF.....**109.0**

1 inch No Bead

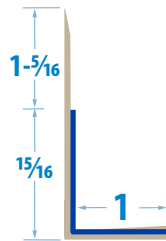

10 ft. Ctn.....**A4-1NB-10**
LBS/MLF.....**109.0**

1-1/4 inch

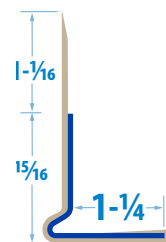

10 ft. Ctn.....**A4-1-1/4-10**
LBS/MLF.....**120.75**

Tape-On Z Shadow Trim

10 ft. Carton	MLF	Pieces/Carton	Cartons/Pallet
AST-1/2-10	109 lbs	50	60
AST-5/8-10	121 lbs	50	60

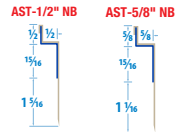

Tape-On Reveal Trim

10 ft. Carton	MLF	Pieces/Carton	Cartons/Pallet
ART-1/2-10	109 lbs	50	60

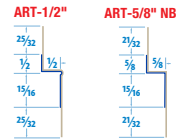

1/2 inch Tape-On J-Trim

7 ft. Carton	8 ft. Carton	10 ft. Carton	MLF	Pieces/Carton	Cartons/Pallet
A9-1/2-7	A9-1/2-8	A9-1/2-10	95 lbs	25	54

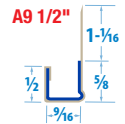

Edge Cap Tape on One Leg

5/8 inch Tape-On J-Trim

7 ft. Carton	8 ft. Carton	10 ft. Carton	MLF	Pieces/Carton	Cartons/Pallet
A9-5/8-7	A9-5/8-8	A9-5/8-10	95 lbs	25	54

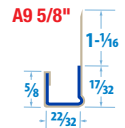

Edge Cap Tape on One Leg

1/2 inch Radius Mini Bull™ Tape-On Outside Corner - Sunline™

MLF: 84 lbs. · Pieces per carton: 50 · Cartons per pallet: 54

7 ft.	8 ft.	8 ft. 6 in.	9 ft.	10 ft.	10 ft. 6 in.	12 ft.
SMB-7	SMB-8	SMB-8.6	SMB-9	SMB-10	SMB-10.6	SMB-12

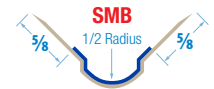

SUN LINE™

3/4 inch Radius Bullnose Tape-On Outside Corner - Sunline™

MLF: 84.18 lbs. · Pieces per carton: 50 · Cartons per pallet: 60

8 ft.	9 ft.	10 ft.
SBN-8	SBN-9	SBN-10

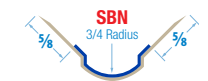

SUN LINE™

Paperfaced Nail-On Corner Bead

90° Paperfaced Nail-On Extra Extra Wide Even Leg Outside Corner - Sunline™

8 ft. Carton	9 ft. Carton	10 ft. Carton	MLF	Pcs/Ctn	Ctns/Pal
S1XXWN-8	S1XXWN-9	S1XXWN-10	117 lbs.	50	60

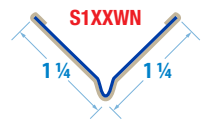

1/2 inch Radius Mini Bull™ Paperfaced Nail-On Outside Corner - Sunline™

8 ft. Carton	9 ft. Carton	MLF	Pcs/Ctn	Ctns/Pal
SMBN-8	SMBN-9	117 lbs.	50	54

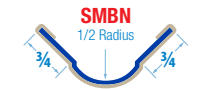

3/4 inch Radius Bullnose Paperfaced Nail-On Outside Corner - Sunline™

8 ft. Carton	9 ft. Carton	10 ft. Carton	MLF	Pcs/Ctn	Ctns/Pal
SBNN-8	SBNN-9	SBNN-10	117.34 lbs.	50	60



3/4 inch Radius Bullnose Paperfaced Nail-On Extra Wide Outside Corner - Sunline™

8 ft. Carton	9 ft. Carton	10 ft. Carton	MLF	Pcs/Ctn	Ctns/Pal
SBNNXW-8	SBNNXW-9	SBNNXW-10	139.03 lbs.	50	54



3/4" Radius Bullnose Nail-On Open Angle Outside Corner - Sunline™

10 ft. Carton	MLF	Pcs/Ctn	Ctns/Pal
SBN-NOA-10	159.5 lbs.	50	60





Notes

GIBRALTAR

BUILDING ACCESSORIES DIVISION

GIBRALTAR BUILDING ACCESSORIES DIVISION

"Provider of Quality Building Accessories, Built Upon Regional Expertise"

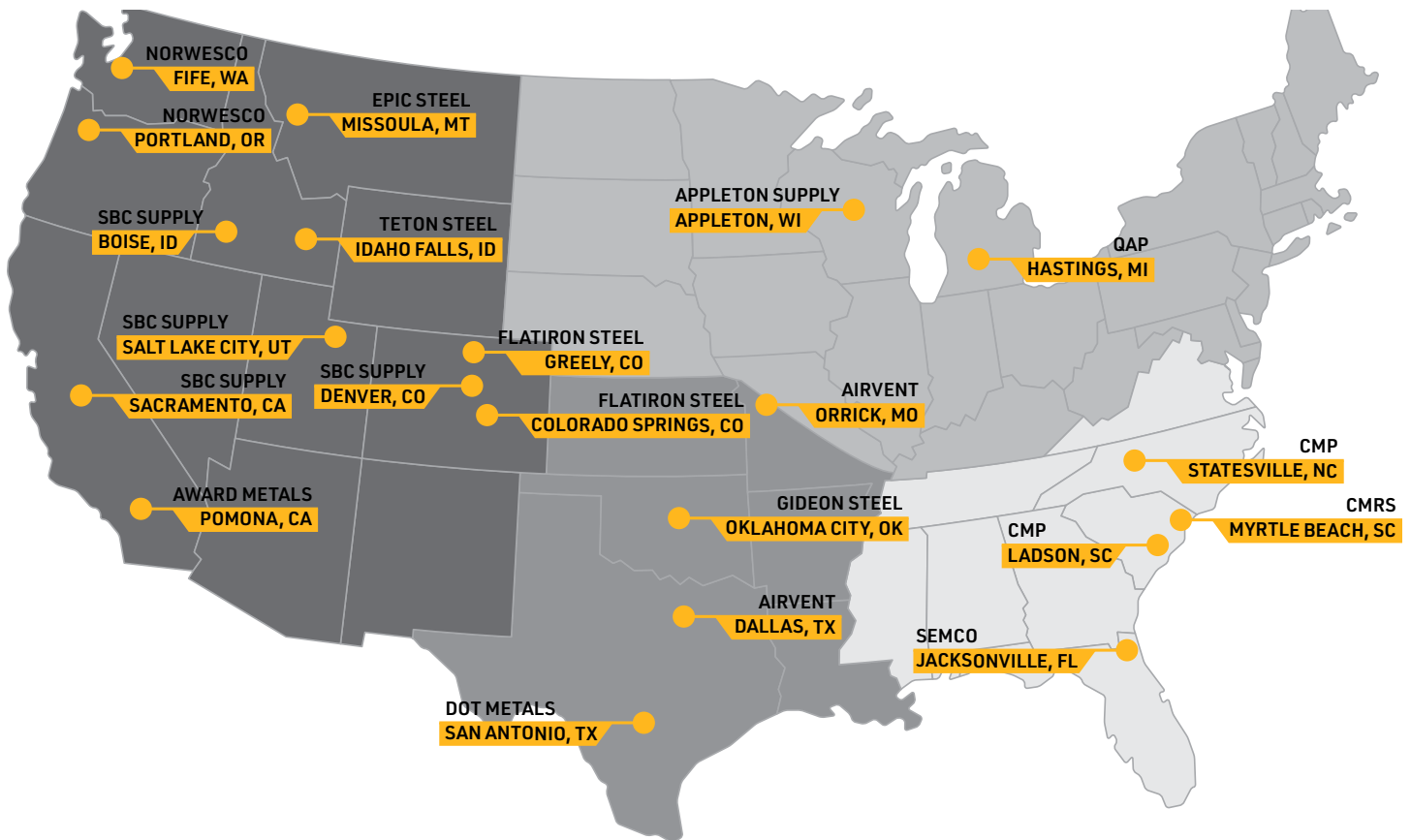

✓ Trims & Flashing

✓ Metal Roofing

✓ Ventilation

✓ Drywall Bead

✓ Stucco & Plaster

✓ Soffit & Fascia

✓ Steel Framing

