



2026 PRODUCT CATALOG



- ✓ Metal Roofing
- ✓ Trims & Flashing
- ✓ Ventilation

Professional Grade



TOLL FREE CUSTOMER SERVICE

800-576-9810

AZ, CA, HI, NV



AWARD METALS
750 S. Reservoir St.
Pomona, CA 71766



Roofing Panels

- 2 ½" Corrugated Roofing Panels..... 3
- SM-Rib 3
- Eave Flashing 3
- Gable Rake 3

Roofing Accessories

- Ridge Cap Flashing 4
- Woodfast Screws 4
- Butyl Tape..... 4

Trims & Flashings

- Bare Metal Drip Edge 5
- Drip Edge Bonderized 5
- Painted Drip Edge 5
- Grip Edge..... 5
- Bare Metal Gravel Stop..... 6
- Painted Gravel Stop 6
- Style-D Eave Drip..... 7
- Tile Riser 7
- Tile Pan 7
- Saddle Stock..... 7
- Bird Stop 7
- Counter Flashing 8
- Bare Metal L-Flashing..... 8
- Painted L-Flashing..... 8
- Bare Metal Roof to Wall..... 9
- Painted Roof to Wall..... 9
- W-Valley 9
- Millwork Z-Flashing 10
- Moss Control Roll..... 10
- Z-Flashing 10

Roll Flashing/Flat Stock

- Galvanized Steel Roll Flashing..... 11
- Aluminum Roll Flashing 11
- Galvanized Flat Shingles..... 11
- Painted Flat Shingles..... 11

Step Flashing

- Painted Step Flashing 12
- Galvanized Step Flashing 12
- Galvanized Step Flashing 12

Pipe Flashing

- Multi Size Pipe Flashing 13
- Galvanized 13
- FHA Pipe Flashing 13
- Aluminum 13
- Flue Guard™ Spark Arrestor Chimney Cap 13
- Plastic 13
- Repair Collar 13

Gable Louvers

- Rectangular Gable Louver 14
- Scupper 14

Rooftop Vents

- Econo Vent 15
- T-Top..... 15
- Total JACK™ 15
- T-Top Sub-Base..... 15
- Code Caps & Bases 15
- Vent Caps..... 15
- Half Round Dormer 16
- Soft Flange Dormer 16
- Kwik Mesh™ 16
- 24 in. Stealth Vent® 16
- Low Profile Dormer..... 16

Sidewall Vents

- Ventilating Access Door 17
- Flat Screen Vent 17
- Two Way Vents..... 17
- Tub Access Door 17
- Dryer Cap..... 17

Eave, Soffit & Foundation Vents

- Eave Vent 18
- Rain Diverter..... 18
- Soffit Vent 18
- Stamped Foundation Vent 18

GIBRALTAR

BUILDING ACCESSORIES DIVISION

"Provider of Quality Building Steel Accessories, Built Upon Regional Expertise"

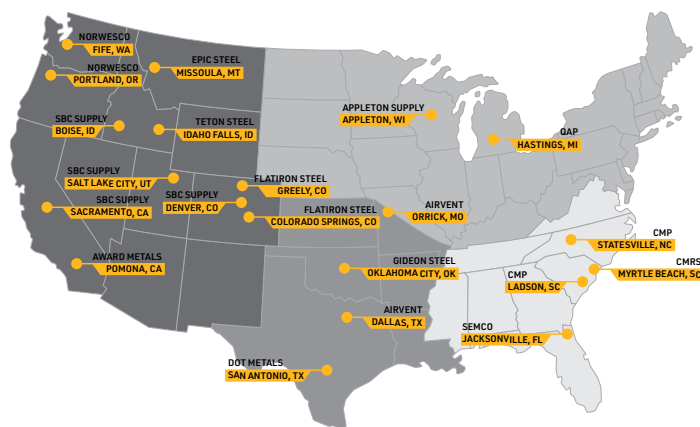

Corrugated

Exposed fastener roofing panel. 21-1/2 inch width roofing coverage. 24 inch width siding coverage.
Applications: Residential, Agricultural, Architectural, Light Commercial, Industrial

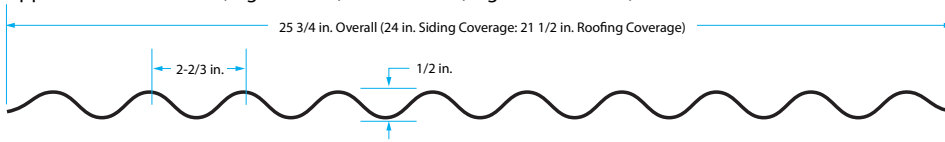

2 1/2" Corrugated Roofing Panels - Pack Quantity: 50

Description	29 Gauge
6 ft.	CR6G-U
8 ft.	CR8G-U
10 ft.	CR10G-U
12 ft.	CR12G-U
14 ft.	CR14G-U
16 ft.	CR16G-U

G90, conforming to ASTM A446

Code Approvals

UL Fire Resistant Directory #R20735
UL Listing Directory #R20735
Florida Building #FL-11175-R1

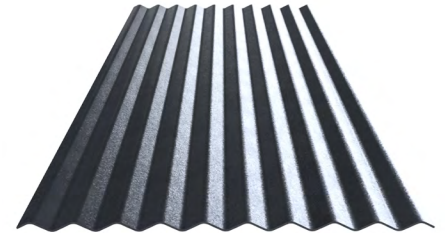

SM-Rib

Exposed fastener roofing and siding panel. 36 inch width coverage.
Applications: Residential, Agricultural, Light Commercial, Industrial



Size	Acrylic/Galv/Zinc	White	Red	Gray	Slate	Black	Green
8 ft.	987601	987609	987618	987627	987635	987646	987655
10 ft.	987602	987610	987619	987628	987636	987647	987656
12 ft.	987603	987611	987620	987629	987637	987648	987657
14 ft.	987604	987612	987621	987630	987638	987649	987658
16 ft.	987605	987613	987622	987631	987639	987650	987659

29 Gauge



1. For the most recent code approval numbers, contact Gibraltar Building Products Technical Department or refer to the appropriate code agency.

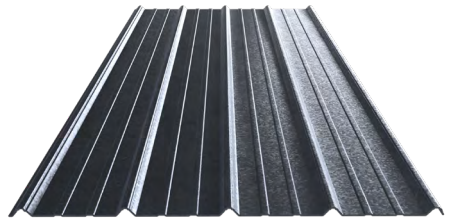

Testing Data & Specifications

Accelerated testing 2000 hours - ASTM G23
Salt Spray testing 1000 hours - ASTM B117
Fire Testing - ASTM E108 or UL 790
Wind Driven Rain - TAS 100

Code Approvals

UL Fire Resistant Directory #R20735
Miami Dade: N.O.A. No. 09-0630.11
Florida Building #FL-11175

Eave Flashing

29 GA	Acrylic/Galv/Zinc	White	Red	Gray	Slate	Black	Green
3 in. x 10 ft.	987606	987614	987623	987632	987640	987651	987660

Gable Rake

28 GA	Acrylic/Galv/Zinc	White	Red	Gray	Slate	Black	Green
2 in. x 10ft	987607	987615	987624	987633	987641	987652	987661

Ridge Cap Flashing

for hip and ridge roof sections. For shingle or metal roof applications.
10 ft. lengths · Galvanized Steel · Pack Quantity: 10

Size	Acrylic/Galv/ Zinc	White	Red	Gray	Slate	Black	Green
2" x 10ft	987608	987616	987625	987634	987642	987653	987662

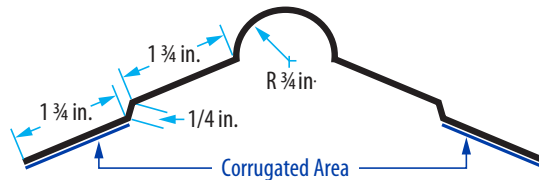

Woodfast Screws

Galvanized #10 Hex-Head with neoprene gasket and self-piercing tip.

Description	White	Red	Black	Green	Galvanized
#10 1-1/2"	987682	987683	987654	987663	987645



Butyl Tape

used to seal metal-to-metal connections.
32 rolls per carton

Description	Part #
50 ft. Butyl Tape	99415

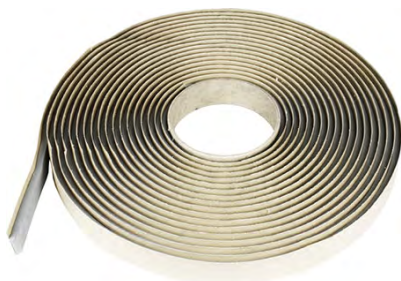

Bare Metal Drip Edge 10 ft. lengths - Pack Quantities: 20

Galvanized: A x B	28 Ga.	26 Ga.
1 in. x 2 in.	RE12G	-
1-1/2 in. x 1-1/2 in.	RE15G	RE15G-26
2 in. x 2 in.	RE22G	RE22G-26
2 in. x 3 in.	RE23G	-
2 in. x 4 in.	RE24G	RE24G-26
2 in. x 6 in.	-	RE26G-26
3 in. x 3 in.	RE33G	RE33G-26
4 in. x 4 in.	RE44G	-

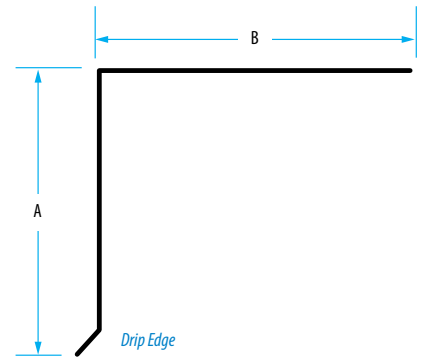

Drip Edge Bonderized

A x B	28 Ga.	26 Ga.
1-1/2 in. x 1-1/2 in.	RE15B	-
2 in. x 3 in.	RE23B	-
2 in. x 4 in 110 Deg	-	RE24B-110-26
2 in. x 4 in	-	RE24B-26

Painted Drip Edge 10 ft. lengths - Pack Quantities: 20

28 Gauge: A x B	Black	Brown	Charcoal	D. Brown	R. Brown	White
1 in. x 2 in	-	-	-	-	-	RE12WH
1-1/2 in. x 1-1/2 in.	RE15BL	RE15BR	RE15CH	RE15BRW	RE15BRU	RE15WH
2 in. x 2 in.	RE22BL	RE22BR	RE22CH	-	RE22BRU	RE22WH
2 in. x 3 in.	-	RE23BR	RE23CH	RE23BRW	RE23BRU	RE23WH
2 in. x 4 in.	-	RE24BR	RE24CH	-	-	RE24WH
3 in. x 3 in.	-	RE33BR	RE33CH	RE33BRW - NW	-	RE33WH

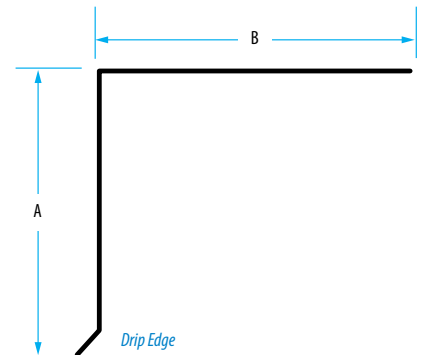

26 Gauge: A x B	Brown	Charcoal	D. Brown	White
1-1/2 in. x 1-1/2 in.	RE15BR-26	RE15CH-26	-	RE15WH-26
2 in. x 2 in.	RE22BR-26	RE22CH-26	-	RE22WH-26
2 in. x 4 in.	RE24BR-26	RE24CH-26	RE24BR-26	RE24WH-26

Grip Edge 28 Gauge - 10 ft. lengths - Pack Quantity: 30

Size: A x B	Galvanized	Brown	Charcoal	White
1 in. x 2 in.	GE12G	-	-	-
1-1/2 in. x 1-1/2 in.	GE15G	GE15BR	GE15CH	GE15WH
2 in. x 2 in.	GE22G	GE22BR	-	GE22WH
2 in. x 3 in.	-	-	-	GE23WH

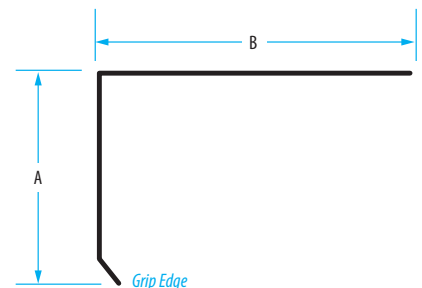

Bare Metal Gravel Stop 28 Gauge · 10 ft. lengths · Pack Quantity: 10

Size: A x B	Galvanized	Bonderized
2 in. x 4 in. + 1/2 in. rise	-	GS24B
3 in. x 4 in. + 1/4 in. rise	CS34G	-
4 in. x 4 in. + 1/2 in. rise	-	GS44B

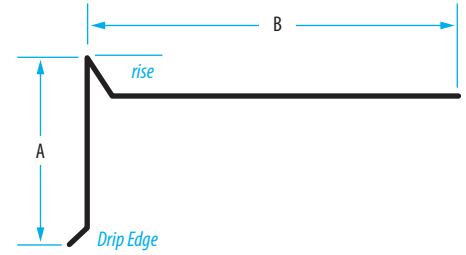

Painted Gravel Stop 28 Gauge · 10 ft. lengths · Pack Quantity: 10

Size: A x B	Brown	White	Charcoal
2 in. x 4 in. + 1/8 in. rise	CS2418BR	CS2418WH	CS2418CH
2 in. x 4 in. + 1/4 in. rise	CS24BR	-	-
3 in. x 3 in. + 1/8 in. rise	CS3318BR	CS3318WH	-

26 Gauge Gravel Stop 10 ft. lengths · Pack Quantity: 10

Size: A x B	Galvanized	White	Bond	Brown	Charcoal
2 in. x 4 in. + 1/8 in. rise	CS2418G-26	CS2418WH-26	CS2418B-26	CS2418BR-26	CS2418CH-26
3 in. x 3 in. + 1/8 in. rise	CS3318G-26	CS3318WH-26	CS3318B-26	-	CS3318CH-26



Style-D Eave Drip 10 ft. lengths · Pack: 25

28 Gauge - Hemmed	
Galvanized	SDG
Dark Brown	SDBRW
Royal Brown	SDBRU
White	SDWH

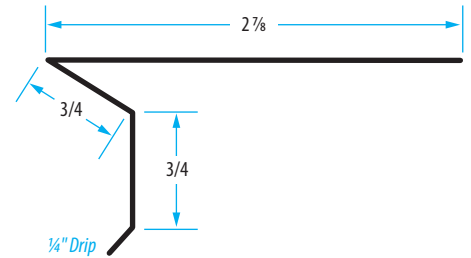

Tile Riser Galvanized Steel · 10 ft. lengths · Pack Quantity: 10 · 4:12 Pitch · Weep & Nail Holes

Color	28 Gauge	26 Gauge
Charcoal	3TR1.5C28	3TR1.5C26
Brown	3TR1.5BR28	3TR1.5BR26
White	3TR1.5WH28	3TR1.5WH26

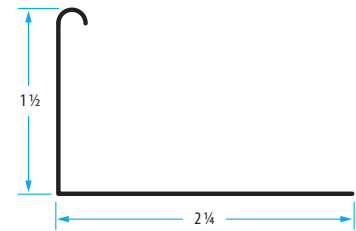

Tile Pan

26 Gauge Galvanized Steel
10 ft. lengths · Pack Quantity: 10

Size: A x B x C	Galvanized
3-1/2 in. x 6 in. x 1/2 in.	TP10G-26
4 in. x 6 in. x 1 in.	TP11G-26
4 in. x 7 in. x 1 in.	TP12G-26
4 in. x 7 in. x 1 in. - 45°	TP12G-26-45

Tile Pan

26 Gauge Zinc
10 ft. lengths · Pack Quantity: 10

Size: A x B x C	Zinc
4 in. x 7 in. x 1 in.	TP12Z-26



Saddle Stock Galvanized Steel · 10 ft. lengths · Pack Quantity 10

Size: A x B	Galvanized
4 in. x 14 in. - 28 Ga.	SS414G
4 in. x 14 in. - 26 Ga.	SS414G-26

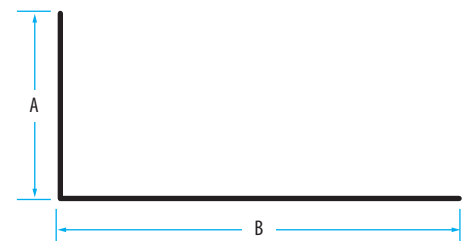

Bird Stop 28 Gauge · Pack Quantity: 10 *Available in 26GA

Color	Eagle Capistrano (28 GA)	Vented Eagle Capistrano (28 GA)	Eagle Malibu	Vented Eagle Malibu	Barcelona	Mon-Mission S	Monier Villa	Espana	US Tile	Tile Riser (28 GA)
Southwest Brown	3BSBR28EC*	-	-	-	-	-	-	-	-	3TR1.5BR28*
Charcoal	3BSC28EC*	3BSC28ECV	3BSC28EM	3BSC28EMV	3BSC28LB	3BSC28MS	3BSC28MV	3BSC28LE	3BSC28US	3TR1.5C28*
Terracota	3BSR28EC	3BSR28ECV	3BSR28EM	3BSR28EMV	3BSR28EMV	3BSR28MS	3BSR28MV	-	3BSR28US	-
White	-	-	-	-	-	-	-	-	-	3TR1.5WH28*

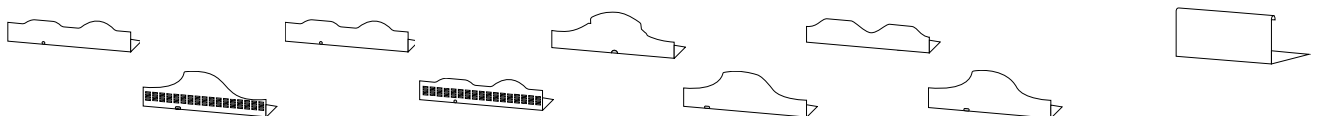

Counter Flashing 26 Gauge · 10 ft. lengths · Pack Quantity: 10

Size: A x B	Galvanized	Zinc
3 in. x 1/2 in.	CF3G-26	3CTF.53Z26
5 in. x 1/2 in.	CF5G-26	-

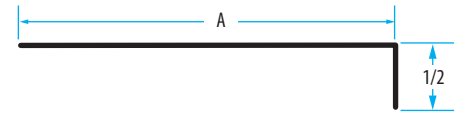

Bare Metal L-Flashing Pack Quantity: 10

Size: A x B	Galvanized		Bonderized	
	28 Ga.	26 Ga.	26 Ga.	28 Ga.
1 in. x 1-1/2 in.	LF115G	-	-	-
1-1/2 in. x 1-1/2 in.	LF15G	-	-	-
1 in. x 2 in.	LF12G	-	-	-
2 in. x 2 in.	LF22G	LF22G-26	-	-
2 in. x 3 in.	LF23G	-	-	-
2 in. x 4 in.	-	LF24G-26	LF24B-26	-
3 in. x 3 in.	LF33G	-	-	LF33B
3 in. x 4 in.	-	LF34G-26	-	-
4 in. x 4 in.	LF44G	LF44G-26	LF44B-26	-
4 in. x 5 in.	LF45G	-	-	-
4 in. x 6 in.	LF46G	LF46G-26	LF46B-26	-
6 in. x 6 in.	LF66G	-	-	-

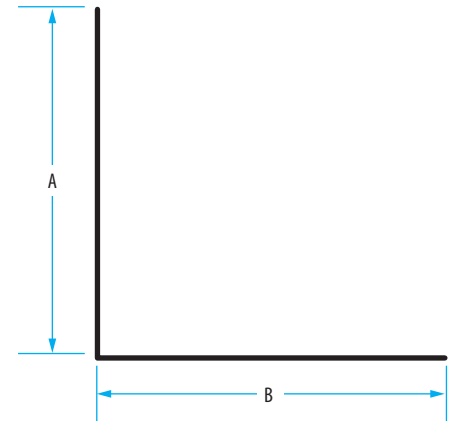

Painted L-Flashing 28 Gauge · Pack Quantity: 10

Size: A x B	Black	White
1.5 in. x 1.5 in.	-	-
4 in. x 4 in.	-	LF44WH
4 in. x 6 in.	-	LF46WH
6 in. x 6 in.	LF66BL	-

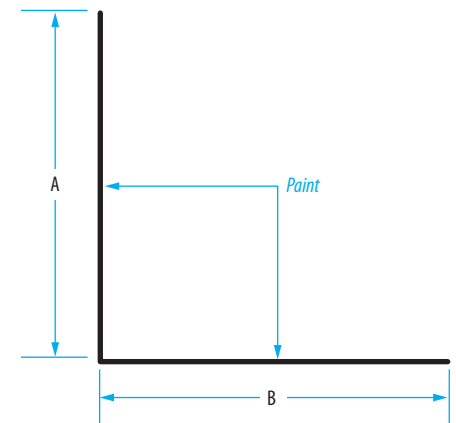

Bare Metal Roof to Wall 10 ft. lengths · Pack Quantity: 10

A x B	Galvanized		Bonderized	Zinc
	28 Gauge	26 Gauge	28 Gauge	26 Gauge
2 in. x 3 in.	RW23G	-	-	-
2 in. x 4 in.	-	RW24G-26	-	RW24Z-26-110
2 in. x 6 in.	-	RW26G-26	RW26B	RW26Z-26-110
3 in. x 5 in.	RW35G	-	-	-
4 in. x 4 in.	-	RW44G-26	-	RW44Z-26-110
4 in. x 5 in.	RW45G-120	-	-	-
4 in. x 6 in.	RW46G	-	-	RW46Z-26-110

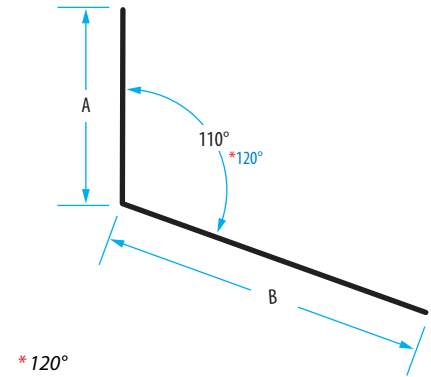

28 Gauge Painted Roof to Wall 10 ft. lengths · Pack Quantity: 20

Size: A x B	Black	Dark Brown
3 in. x 5 in.	RW35BL	RW35BRW

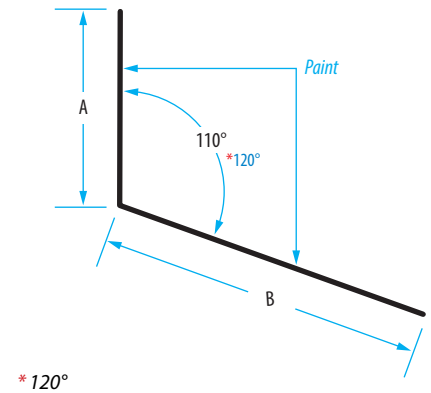

28 Gauge W-Valley 10 ft. lengths · Pack Quantity: 10

Description	Galv.	Black	Brown	Charcoal	White
18 in. - Hemmed	V18G	-	V18BR	V18CH	-
24 in. - Hemmed	V24G	V24BL	V24BR	V24CH	V24WH

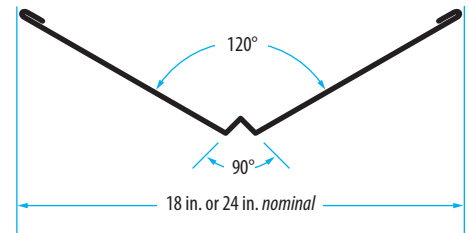

26 Gauge W-Valley 10 ft. lengths · Pack Quantity: 10

Description	Galv.	White	Brown	Charcoal	Zinc
18 in. - No Hem	-	V18WH-26	V18BR-26	V18CH-26	-
24 in. - Hemmed	V24G-26	V24WH-26	V24BR-26	V24CH-26	-
24 in. - Open Hem	V24GOH-26	-	-	-	-
24 in. - 3 Rib, Hemmed	-	-	-	-	V24Z3R-26
24 in. - 3 Rib, Open Hemmed	-	-	-	-	V24Z3ROH-26
24 in. - 5 Rib, Open Hemmed	-	-	-	-	V24Z5R-26

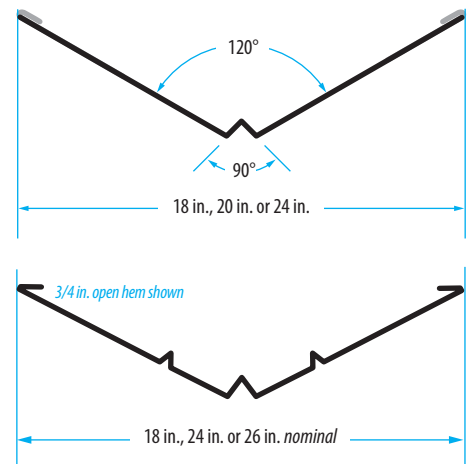

28 Gauge Z-Flashing 10 ft. lengths · 28 Gauge Galvanized Steel · Pack Quantity: 20

Size: A x B x C	Galvanized	Bonderized	White
3/8 in. x 3/8 in. x 2 in.	SZB38G	-	SZB38WH
3/8 in. x 7/16 in. x 2-1/4 in.	SZB716G	-	-
3/8 in. x 1/2 in. x 2-1/8 in.	SZB12G	-	-
3/8 in. x 5/8 in. x 2 in.	SZB58G	SZB58B	SZB58WH
3/8 in. x 3/4 in. x 1-7/8 in.	SZB34G	-	-
3/8 in. x 1 in. x 2 in.	SZB1G-2	-	-
2 in. x 1 in. x 3 in.	ZB6G	ZB6B	-
3/8 in. x 1-1/2 in. x 2 in.	SZB115G-2	-	-
3/8 in. x 1-1/8 in. x 2 in.	SZB118G-2	-	-
3/8 in. x 1-1/4 in. x 2 in.	SZB125G-2	-	-
3/8 in. x 7/16 in. x 2-3/16 in.	SZB716G	-	-
3/8 in. x 7/16 in. x 2-3/16 in.	SZB716G	-	-

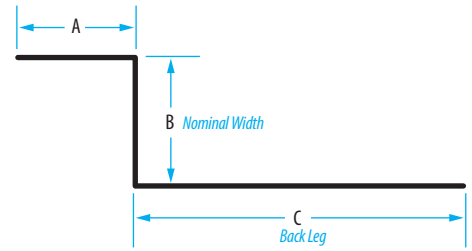

26 Gauge Z-Flashing 10 ft. lengths · 26 Gauge Galvanized Steel · Pack Quantity: 20

Size: A x B x C	Galvanized
2 in. x 1 in. x 2 in.	ZB5G-26
2 in. x 1 in. x 3 in.	ZB6G-26
2 in. x 1-1/2 in. x 2 in.	ZB55G-26

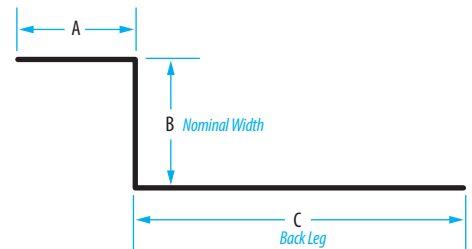

Millwork Z-Flashing 10 ft. lengths · 28 Gauge Galvanized Steel · Pack Quantity: 20

Size: A x B x C	Galvanized	Bonderized	White
3/8 in. x 1-1/8 in. x 2 in.	SZB118G-2	-	SZB118WH-2
3/8 in. x 1-1/4 in. x 2 in.	SZB125G-2	-	-
3/8 in. x 1-1/2 in. x 2 in.	SZB115G-2	-	-
1/4 in. x 1-1/4 in. x 1-3/8 in.	FLGAWF	-	-
1/2 in. x 1-1/2 in. x 2 in.	WT22G	WT22B	-

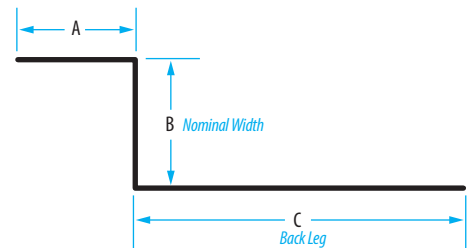

Moss Control Roll

Zinc strip to prevent moss from growing.
6 rolls per carton

Description	Part #
2-1/2 in. x 50 ft. with nails	MB50



Galvanized Steel Roll Flashing

Size	30 Gauge			28 Gauge		26 Gauge
	10 ft.	25 ft.	50 ft.	25 ft.	50 ft.	50 ft.
8 in.	-	-	-	-	-	RV850G-26
10 in.	RV1010G	RV1025G	RV1050G-30	-	-	-
12 in.	-	-	-	RV1225G	-	-
14 in.	-	-	-	RV1425G	RV1450G	-
20 in.	-	-	-	RV2025G	RV2050G-28	RV2050G-26



Aluminum Roll Flashing

Size	10 ft.	25 ft.	50 ft.
6 in.	-	RV625A	-
7 in.	RV710A	-	RV750A
8 in.	-	RV825A	-
10 in.	RV1010A	-	RV1050A
14 in.	RV1410A	RV1425A	RV1450A
20 in.	RV2010A	RV2025A	RV2050A



Flat Stock & Step Flashing

Galvanized Flat Shingles

Size	Part #	QTY
5 in. x 7 in. 26 Ga. Galvanized Steel - 50pk	S57G-26-50	50
5 in. x 7 in. 28 Ga. Galvanized Steel - 25 pack	S57G-25	25
5 in. x 7 in. 28 Ga. Galvanized Steel - 50pk	S57A-50	50
5 in. x 7 in. 28 Ga. Galvanized Steel - each	S57EA-200	200
6 in. x 8 in. 26 Ga. Galvanized Steel	S68G-26-100	100
6 in. x 8 in. 26 Ga. Galvanized Steel	S68G-26-50	50
6 in. x 8 in. 28 Ga. Galvanized Steel	S68G-100	100
8 in. x 12 in. 26Ga. Galvanized steel - 50pk	S812GAL-26-50	50
8 in. x 12 in. 26Ga. Galvanized steel - each	S812G-50EA	50
8 in. x 12 in. 28 Ga. Galvanized Steel - each	S812EA-100	100
8 in. x 8 in. 28 Ga. Galvanized Steel - 25 pack	S88G-25	25

Painted Flat Shingles

Dark Brown • 28 Gauge

28	Part #	Qty
8" x 12"	S812BRWEA-100	100
8" x 12"	S812BREAA-26-50	50

Brown • 28 Gauge

28	Part #	Qty
6" x 8"	S68BR-100	100
6" x 8"	S68BR-26-100	100
6" x 8"	S68BR-50	50
6" x 8"	S68BR-26-50	50
8" x 12"	S812BR-50	50

Charcoal • 28 Gauge

28	Part #	Qty
5" x 7"	S57CH-26-50	50
8" x 12"	S812CH-50EA	50
8" x 12" - 26 GA	S812CH-26-50	100

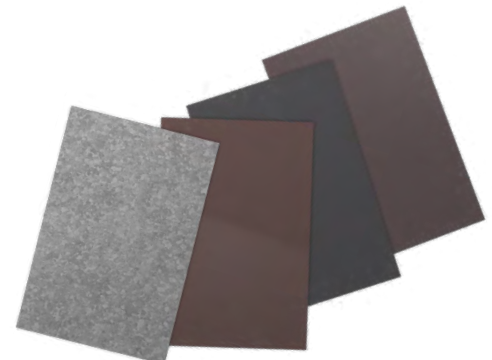

30 Gauge Galvanized Step Flashing

Description	Part #	QTY
4 in. x 4 in. x 12 in. - 30 Gauge	SF4412G-30-50	50

28 Gauge Galvanized Step Flashing

Description	Part #	QTY
3 in. x 3 in. x 7 in. - 28 Gauge - 25 pack	SF337G-25	25
3 in. x 4 in. x 7 in. - 28 Gauge - each	SF347EA-200	200
3 in. x 4 in. x 7 in. - 30 Gauge - each	SF347G-30-50	50
3 in. x 5 in. x 7 in. - 26 Gauge	SF357G-26-100	100
3 in. x 5 in. x 8 in. - 28 Gauge. - 25 pack	SF358G-25	25
4 in. x 4 in. x 8 in. - 28 Gauge - each	SF448EA-50	50
4 in. x 4 in. x 8 in. - 28 Gauge - each	SF448G-100	100
4 in. x 4 in. x 12 in. - 28 Gauge - each	SF4412EA-100	100
4 in. x 6 in. x 14 in. - 28 Gauge - each	SF4614EA-50	50

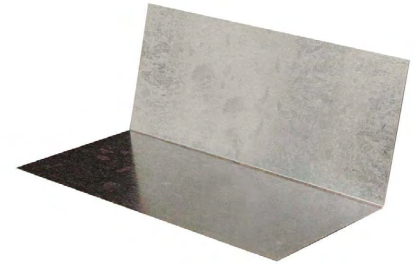

Step Flashing with the word "each" in the description are individually bar coded.

Painted Step Flashing

Black - 26 & 28 Gauge

Size	Part #	QTY
4 x 4 x 12 in. - 28 Gauge - each	SF4412BLEA-100	100



Black

Dark Brown - 28 Gauge

28 Gauge	Part #	QTY
4 x 4 x 12 in. - each	SF4412BRWEA-100	100



Dark Brown



Multi Size Pipe Flashing

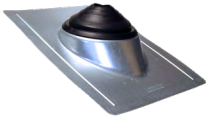

Galvanized Multi Size 1-1/4" - 4"

Part #	Color	QTY
56001	Mill Finish	12
56009	Black	12
56010	Brown	12
56011	Weatherwood	12

Aluminum Multi Size 1-1/4" - 4"

Part #	Color	QTY
56002	Mill Finish	12
56020	Black	12
56021	Brown	12
56022	Weatherwood	12



Plastic Multi Size 1-1/4" - 4"

Part #	QTY
56003	12

Repair Collar Multi Size 1-1/4" - 4"

Part #	QTY
56000	20

Aluminum FHA Pipe Flashing Pack Quantity: 25



Galvanized FHA Pipe Flashing Pack Quantity: 25



Size	Part #
1/2 in.	3FL.5A
3/4 in.	3FL.75A
1 in.	3FL1A
1-1/2 in.	3FL1.5A
2 in.	3FL2A
3 in.	3FL3A
4 in.	3FL4A
5 in.	3FL5A
8 in.	3FL8A
14 in.	3FL14A
10 in.	3FL10A
4 in. Oval	3FL4AO

Size	Oval
1/2 in.	3FF.5G26
3/4 in.	3FF.75G26
1 in.	3FF1G26
1-1/2 in.	3FF1.5G26
2 in.	3FF2G26
3 in. Soil	3FF3G26
4 in.	3FF4G26
5 in.	3FF5G26
6 in.	3FF6G26

Flue Guard™ Spark Arrestor Chimney Cap

- Sloped lid • 20 gauge powder coated steel
- No tools required • 5/8 in. mesh
- Universal fit: 6 in. x 9 in. up to 14 in. X 22 in.



Genuine 5/8" mesh meets the strict California Fire Code!

Galvanized Standard Pipe Flashing Pack Quantity: 25

Size	Oval
1/2 in.	3STF.5G26
3/4 in.	3STF.75G26
1 in.	3STF1G26
1-1/2 in.	3STF1.5G26
2 in.	3STF2G26
3 in. Soil	3STF3G26
4 in.	3STF4G26
5 in.	3STF5G26
6 in.	3STF6G26

Description	Part #	QTY
Flue Guard™ Chimney Cap	CG4BLK	1

Rectangular Gable Louver Flange Center 1/8 inch galvanized insect screen · Pack Quantity: 10

Size: A x B	N.F.V.	Brown	White
12 in. x 12 in.	50.5 sq. in.	-	GLFC1212WH
12 in. x 18 in.	79.0 sq. in.	-	GLFC1218WH
14 in. x 18 in.	93.4 sq. in.	-	GLFC1418WH
14 in. x 24 in.	131.6 sq. in.	-	GLFC1424WH

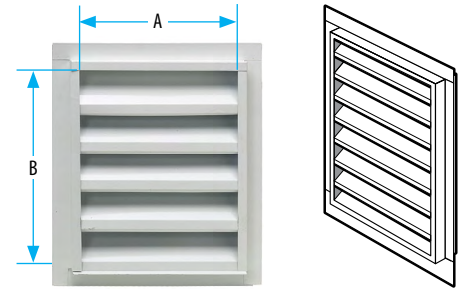

Rectangular Gable Louver Flange Front 1/8 inch galvanized insect screen

Size: A x B	N.F.V.	White	QTY
12 in. x 12 in.	50.5 sq. in.	GLFF1212WH-1/8	10
12 in. x 18 in.	79.0 sq. in.	GLFF1218WH-1/8	10
14 in. x 12 in.	56.2 sq. in.	GLFF1412WH-1/8	10
14 in. x 18 in.	93.4 sq. in.	GLFF1418WH-1/8	10
14 in. x 24 in.	131.6 sq. in.	GLFF1424WH-1/8	10

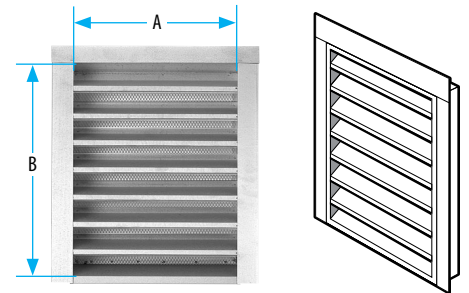

Rectangular Gable Louver Plaster Ground 1/8 inch galvanized insect screen

Size: A x B	N.F.V.	Galvanized	QTY
12 in. x 12 in.	50.5 sq. in.	GLPG1212G-1/8	10
12 in. x 18 in.	79.0 sq. in.	GLPG1218G-1/8	10
14 in. x 12 in.	56.2 sq. in.	GLPG1412G-1/8	10
14 in. x 18 in.	93.4 sq. in.	GLPG1418G-1/8	10
14 in. x 24 in.	131.6 sq. in.	GLPG1424G-1/8	10
18 in. x 24 in.	170.8 sq. in.	GLPG1824G-1/8	5

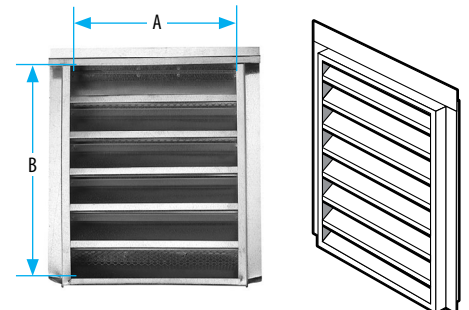

7/8 in. Ground

Scupper Left

26 Gauge Galvanized · Pack Quantity: 5 pcs

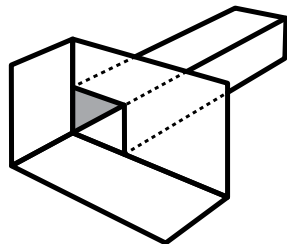

Size: A x B	Part #
3 in. x 4 in. + 10 in. tube	3SPL34G26

Scupper Center

26 Gauge Galvanized · Pack Quantity: 5 pcs

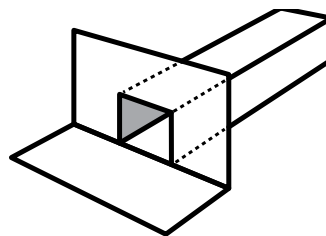

Size: A x B	Part #
2 in. x 3 in. + 10 in. tube	3SPC23G26
3 in. x 4 in. + 10 in. tube	3SPC34G26
4 in. x 6 in. + 10 in. tube	3SPC46G26

Scupper Right

26 Gauge Galvanized · Pack Quantity: 5 pcs

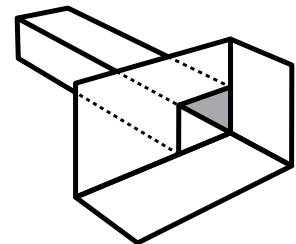

Size: A x B	Part #
3 in. x 4 in. + 10 in. tube	3SPR34G26
6 in. x 6 in. + 10 in. tube	3SPR66G26

Econo Vent 26 Gauge Galvanized Steel · Flat roof.

Size	N.F.V.	Part#	QTY
12 in. x 12 in.	102 sq. in.	1212EV	2
12 in. x 12 in. - Removeable Top	102 sq. in.	1212EV-RT	2
14 in x 14 in	123 sq. in.	1414EV	2
14 in. x 14 in. - Removeable Top	123 sq. in.	1414EV-RT	2
16 in x 16 in	144 sq. in.	1616EV	2
18 in. x 18 in.	240 sq. in.	1818EV	2

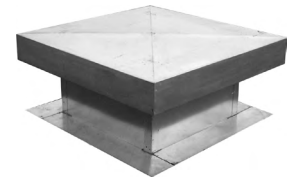

T-Top 26 Gauge

Description	Aluminum	Galvanized	Bonderized	QTY
4 in. FHA Base	3TT4A	3TT4G26	-	1
4 in. FHA Base with Cap and Screen	-	3TT4G26-EC	-	1
4 in. Standard Base	-	RJ4G	RJ4B	12
4 in. w/screen	-	3TT4G26-S	-	1
7 in. FHA Base	3TT7A	3TT7G26	-	1
7 in. FHA Base with Cap and Screen	-	3TT7G26-EC	-	1
7 in. Standard Base	-	RJ7G	RJ7B	8
7 in. w/screen	-	3TT7G26-S	-	1



Total JACK™ The only roof jack with an adjustable stack. Adjusts to fit most roof pitches.

Size	Black	QTY
6 in.	JACK6BLK	7
8 in.	JACK8BLK	6

Patent#: US 8,534,013 B3
Patent#: US 8,615,943 B2



T-Top Sub-Base

Size	Part #	QTY
4 in. Sub Base - 28 Ga.	SJ4G	20

Code Caps & Bases
Tops Only

Size	Part #	CTN/QTY
4 inch cap	CC4T	24
6 inch cap	CC6T	24
8 inch cap	CC8T	24



Top

Bases Only

Size	Part #
4 inch	CC4B
6 inch	CC6B
8 inch	CC8B

Vent Caps

Size	Round	Oval	QTY
3 inch	RBVC3	-	24
4 inch	RBVC4	OBVC4	24
5 inch	RBVC5	-	12
6 inch	RBVC6	-	6



Oval



Round



Half Round Dormer

Size	N.F.V.	Part #
24 in. x 12 in.	100	BH24-1/8

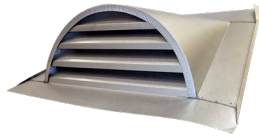

Low Profile Dormer

Galvanized Steel · Hard Flange · 1/8 in. mesh

Size	N.F.V.	Part #
19 in. x 4 in.	46 sq. in.	LPDG19-1/8



Soft Flange Dormer

1/8 in. galvanized mesh.

Galvanized Steel + Soft Aluminum Flange for curved tile roofs

Size	N.F.V.	Part #
18" Galvanized with Aluminum 2 sides	64	STDH18GB
18" Galvanized with Aluminum 3 Sides	60	STDS18-3B
24 x 12 - Aluminum 2 sides	104	STDS24-2B-1/8
24 x 12 - Aluminum 3 sides	104	STDS24-3B

Kwik Mesh™

Galvanized - 1/8 in. mesh

Size	Part #	QTY.
4 in. x 25 ft.	KM425	6 rolls
6 in. x 25 ft.	KM625	6 rolls
8 in. x 25 ft.	KM825	3 rolls
12 in. x 20 ft.	KM1220	3 rolls

KM425 34.08 sq. in./ft. N.F.A.

KM625 51.12 sq. in./ft. N.F.A.

KM825 68.16 sq. in./ft. N.F.A.

KM1220 102.24 sq. in./ft. N.F.A.



24 in. Stealth Vent®

39 sq. in. N.F.V. · 26 Gauge

Description	No Hem	Hemmed	QTY
Zinc	3STH24Z26ANH	3STH24Z26AB	50
Zinc w/ Black Mesh Screen	3STH24Z26ANHB	-	50

Roof Deck Opening: 14 in. x 5 in. Hemmed Vent for Tile Roofs; requires Sub-Base.
Sub Base not required for unhemmed composition shingle application.



Black Mesh, 36, & 48 inch Stealth Vents available upon request, order minimum 100. Contact your Gibraltar Rep for further details.



Ventilating Access Door

1/8 inch mesh · For crawl space access

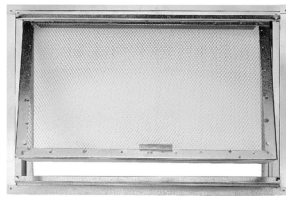

18 in. x 24 in. | R.O.: 18.25 in. x 25 in.

Description	Part #	QTY
Ventilating Access Door	CHADS-1/8	10

Tub Access Door

Pressure fit door · Drywall Frame



14 in. x 14 in.

Description	Part #	QTY
Tub Access Door	TA14DW	10

4 Inch Dryer Cap



Description	Part #	QTY
Galvanized Steel	DV4	14

Flat Screen Vent Galvanized Steel · 1/8 in. mesh

Size: A x B	N.F.V.	Rough Opening	Part #	QTY
16 in. x 4 in.	23.7 sq. in.	14.5 in. x 2.5 in.	SCV164-1/8	25
16 in. x 6 in.	42.6 sq. in.	14.5 in. x 4.5 in.	SCV166-1/8	25
16 in. x 8 in.	61.5 sq. in.	14.5 in. x 6.5 in.	SCV168-1/8	25

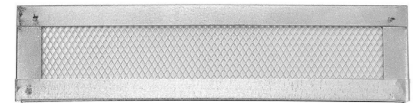

Two Way Vents Galvanized steel · 1/8 in. mesh · Reversible flange for plaster or surface mount

Size: A x B	N.F.V.	Rough Opening	Part #	QTY
14 in. x 4 in.	28.4 sq. in.	13.75 in. x 3.25 in.	TW144-1/8	30
14 in. x 6 in.	44.8 sq. in.	13.75 in. x 5.25 in.	TW146-1/8	24
14 in. x 8 in.	62.2 sq. in.	13.75 in. x 7.25 in.	TW148-1/8	16

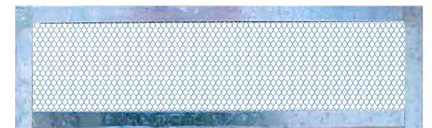

Two Way Vent With decorative floral plastic insert

Description	Part #	QTY
14 in. x 6 in. Vent + Insert	TWPIV-1/8	24
Insert only	PIV614	24



Mini Louver Aluminum, no Screen

Size	N.F.V.	Part #	QTY
2 inch	0.47 sq. in.	ML2	100
3 inch	1.34 sq. in.	ML3	50
4 inch	2.88 sq. in.	ML4	20





Soffit Vent Stucco Ready · 1/8 inch mesh

Size: A x B	N.F.V.	Rough Opening	Part #	QTY
14 in. x 5 in.	52.1 sq. in.	14.5 in. x 5.5 in.	SV145-1/8	26
22 in. x 3 in.	51.4 sq. in.	22.5 in. x 3.25 in.	SV223-1/8	9

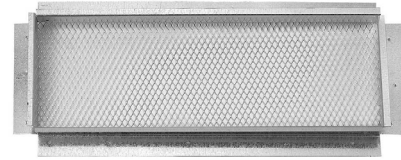

Eave Vent Stucco or Straight Flange · 1/8 inch mesh

Size	N.F.V.	Galvanized	QTY
14 in. x 6 in.		EV614-1/8	25
22 in. x 3 in. - 1/8 mesh - STU	34.3 sq. in.	EV223-1/8	25
22 in. x 6 in.		EV622-1/8	25

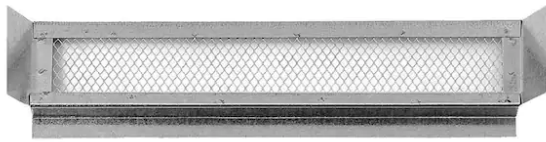

STU = Stucco Flange REG = Straight Flange

Stamped Foundation Vent Stucco Reveal

Galvanized

Description	N.F.V.	Part #	QTY
14 x 6 in. - 1/8 mesh	51 sq. in.	FV146G-1/8	25

Bonderized

14 x 6 in. - 1/4 mesh	51 sq. in.	FV146B-1/8	25
------------------------------	------------	------------	----



Rain Diverter

Rain Diverter

Description	Part #	QTY
28 Ga. Galvanized - 1 1/2 in. x 4 in. x 1/2 in. - 6 ft. Length	RD672G	20

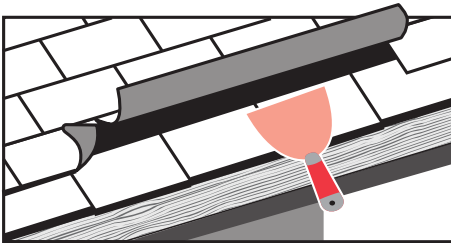
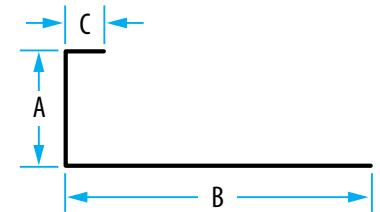

Gently lift 2nd row of shingles, directly above the doorway.

Rain Diverter can also be used to evenly disperse 2nd story downspout runoff to a pitched 1st story roof.

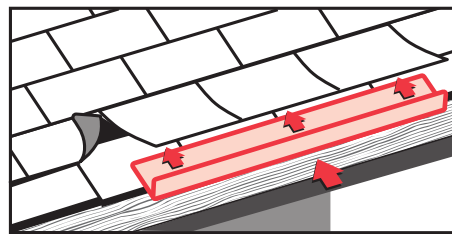

Slide Rain Diverter under shingles as far as it will go, giving it a slight pitch to one side.

Your Rain Diverter should extend at least 1 ft. on either side of the doorway. Cut to desired length with tin snips. For lengths greater than 60 in., overlay 2 or more Rain Diversers.

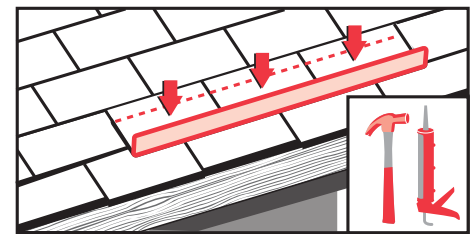

Fasten with 3 hot dipped galvanized roofing nails.

Seal nail heads with roofing cement and press shingles back into place.

-AWARD-
M E T A L S